

INSTALLATION MANUAL

AIR-TO-WATER HEAT PUMP

Please read this installation manual completely before installing the product. Installation work must be performed in accordance with the national wiring standards by authorized personnel only. Please retain this installation manual for future reference after reading it thoroughly.

THERMA V™ (For High temp. model only)

Original instruction



MFL67212828
Rev.11_021422

www.lg.com
Copyright © 2019 - 2022 LG Electronics Inc. All Rights Reserved.

POLSKI

ENGLISH

ČEŠTINA

FRANÇAIS

ΕΛΛΗΝΙΚΑ

PORTUGUÊS

MAGYAR

БЪЛГАРСКИ

SRPSKI

HRVATSKI

SLOVENŠČINA

ESPAÑOL

TABLE OF CONTENTS

4 PREFACE

5 SAFETY INSTRUCTIONS

12 INSTALLATION PART

13 GENERAL INFORMATION

- 13 Model Information
- 15 Model name and related information
- 16 Parts and Dimensions
- 19 Control Parts
- 20 Control Panel
- 21 Typical Installation Example
- 22 Cycle Diagram

23 INSTALLATION

- 23 Transporting the Unit
- 24 Selection of the best location
- 26 Installation Space
- 30 Collective / Continuous Installation for roof top use
- 31 Installation at Seaside
- 31 Seasonal wind and cautions in winter
- 32 Foundation for Installation

33 INSTALLATION OF INDOOR UNIT

- 33 Electrical Wiring

36 PIPING AND WIRING FOR OUTDOOR UNIT

- 36 Refrigerant Piping
- 36 Drill a Hole in the Wall
- 37 Preparation for Piping
- 38 Connecting Pipe to Indoor Unit
- 38 Connecting Pipe to Outdoor Unit
- 41 Finalizing
- 42 Leakage test and Evacuation
- 44 Electrical Wiring

47 PIPING AND WIRING FOR INDOOR UNIT

- 47 Water Piping and Water Circuit Connection
- 51 Water pump Capacity
- 51 Water Quality
- 52 Frost protection

53 ACCESSORIES INSTALLATION

- 55 Before Installation
- 55 Thermostat
- 58 3rd Party Controller
- 59 Central Controller
- 60 DHW Tank
- 61 Dry Contact
- 63 External Controller - Setting up programmable digital input operation
- 64 Remote Temperature Sensor
- 66 External pump

67	Wi-fi Modem
68	Smart Grid
69	3Way Valve(A)
70	Wired Remote Controller

72 CONFIGURATION

72	DIP Switch Setting
----	--------------------

78 SERVICE SETTING

78	How to enter service setting
78	Service setting
79	Service contact
80	Model information
81	RMC version Information
82	Open source license

83 INSTALLER SETTING

83	How to enter installer setting
84	Installer setting
86	3 Minutes Delay
87	Select Temperature Sensor
88	Dry Contact Mode
89	Central Control Address
90	Pump test run
91	Air heating set temp.
92	Water heating set temp
93	DHW set temp
94	Outdoor temp. for auto mode
95	Indoor air temp. for auto mode
96	LWT temp. for auto mode
97	Tank disinfection setting 1, 2
98	Tank setting 1
99	Tank setting 2
100	DHW time setting
101	TH on/off Variable, heating air
102	TH on/off Variable, heating water
103	Heating temp. setting
104	Pump setting in heating
105	Forced operation
106	CN_CC
107	Smart Grid(SG)
108	IDU Address Verification
109	CN_EXT
110	Use External Pump
111	Pump Prerun/Overrun
112	Data logging
113	Password Initialization
114	Power Supply Blockage (SG Ready)
115	Overview settings

117 COMMISSIONING

117	Check List before Starting Operation
118	Starting Operation
119	Starting Operation flow chart
119	Airborne Noise Emission
119	Limiting concentration(R410A)
120	Troubleshooting

PREFACE

This installation manual is to present information and guide about understanding, installing, and checking **THERMAV**.

Your careful reading before installation is highly appreciated to make no mistake and to prevent potential risks. The manual is divided into ten chapters. These chapters are classified according to installation procedure. See the table below to get summarized information.

Chapters	Contents
Chapter 1	<ul style="list-style-type: none"> Warning and Caution concerned with safety. This chapter is directly related with human safety. We strongly recommend reading this chapter carefully.
Chapter 2	<ul style="list-style-type: none"> Items Inside product Box Before starting installation, please make it sure that all parts are found inside the product box.
Chapter 3	<ul style="list-style-type: none"> Fundamental knowledge about THERMAV. Model identification, accessories information, refrigerant and water cycle diagram, parts and dimensions, electrical wiring diagrams, etc. This chapter is important to understand THERMAV.
Chapter 4	<ul style="list-style-type: none"> Installation about the outdoor unit. Installation location, constraints on installation site, etc
Chapter 5	<ul style="list-style-type: none"> Installation about the indoor unit. Installation location, constraints on installation site, etc Constrains when accessories are installed
Chapter 6	<ul style="list-style-type: none"> How to perform piping (for refrigerant) and wiring at the outdoor unit. Refrigerant pipe connection between the indoor unit and the outdoor unit. Electrical wiring at the outdoor unit.
Chapter 7	<ul style="list-style-type: none"> How to perform piping (for water) and wiring at the indoor unit. Water pipe connection between the indoor unit and pre-built under floor water loop pipe. Electrical wiring at the indoor unit. System set-up and configuration. As many control parameters of THERMAV is adjustable by control panel, deep understanding about this chapter is required to secure the operation flexibility of THERMAV. For more detailed information, please read the separate operation manual to use control panel and adjust control parameters.
Chapter 8	<ul style="list-style-type: none"> Information about supported accessories Specification, Constraints, and wiring are described. Before purchasing accessories, please find supported specification to buy proper one.
Chapter 9	<ul style="list-style-type: none"> Test operation and check point while test running.
Chapter 10	<ul style="list-style-type: none"> Check points before starting operation are explained. Troubleshooting, maintenance, and error code list are presented to correct problems.

REMARK : ALL CONTENTS OF THIS MANUAL ARE SUBJECT TO CHANGE WITHOUT NOTICE. TO GET THE LATEST INFORMATION, PLEASE VISIT LG ELECTRONICS WEB SITE.

SAFETY INSTRUCTIONS

The following safety guidelines are intended to prevent unforeseen risks or damage from unsafe or incorrect operation of the appliance.

The guidelines are separated into 'WARNING' and 'CAUTION' as described below.

 This symbol is displayed to indicate matters and operations that can cause risk.
Read the part with this symbol carefully and follow the instructions in order to avoid risk.

WARNING

This indicates that the failure to follow the instructions can cause serious injury or death.

CAUTION

This indicates that the failure to follow the instructions can cause the minor injury or damage to the product.

WARNING

Installation

- Do not use a defective or underrated circuit breaker. Use this appliance on a dedicated circuit.
 - There is risk of fire or electric shock.
- For electrical work, contact the dealer, seller, a qualified electrician, or an Authorized Service Center.
 - There is risk of fire or electric shock.
- Always ground the unit.
 - There is risk of fire or electric shock.
- Install the panel and the cover of control box securely.
 - There is risk of fire or electric shock.
- Always install a dedicated circuit and breaker.
 - Improper wiring or installation may cause fire or electric shock.

- Use the correctly rated breaker or fuse.
 - There is risk of fire or electric.
- Do not modify or extend the power cable.
 - There is risk of fire or electric shock.
- Do not install, remove, or reinstall the unit by yourself (customer).
 - There is risk of fire, electric shock, explosion, or injury
- For antifreeze, always contact the dealer or an authorized service center.
 - Almost the antifreeze is a toxic product.
- For installation, always contact the dealer or an authorized Service Center.
 - There is risk of fire, electric shock, explosion, or injury.
- Do not install the unit on a defective installation stand.
 - It may cause injury, accident, or damage to the unit.
- Be sure the installation area does not deteriorate with age.
 - If the base collapses, the unit could fall with it, causing property damage, unit failure, and personal injury.
- Do not install the water pipe system as Open loop type.
 - It may cause failure of unit.
- Use a vacuum pump or inert (nitrogen) gas when doing leakage test or purging air. Do not compress air or oxygen and do not use flammable gases.
 - There is the risk of death, injury, fire or explosion.
- Make sure the connected condition of connector in product after maintenance.
 - Otherwise, it may cause product damage.
- Do not touch leaked refrigerant directly.
 - There is risk of frostbite.
- Copper in contact with refrigerants shall be oxygen-free or deoxidized, for example Cu-DHP as specified in EN 12735-1 and EN 12735-2.
- Compliance with national gas regulations shall be observed.
- Refrigerant tubing shall be protected or enclosed to avoid damage.
- The installation of pipe-work shall be kept to a minimum.

- A brazed, welded, or mechanical connection shall be made before opening the valves to permit refrigerant to flow between the refrigerating system parts. A vacuum valve shall be provided to evacuate the interconnecting pipe and/or any uncharged refrigerating system part.
- Any person who is involved with working on or breaking into a refrigerant circuit should hold a current valid certificate from an industry-accredited assessment authority, which authorises their competence to handle refrigerants safely in accordance with an industry recognised assessment specification.
- Do not use means to accelerate the defrosting process or to clean, other than those recommended by the manufacturer.
- Do not pierce or burn.
- Be aware that refrigerants may not contain an odour.
- Dismantling the unit, treatment of the refrigerant oil and eventual parts should be done in accordance with local and national standards.
- Flexible refrigerant connectors (such as connecting lines between the indoor and outdoor unit) that may be displaced during normal operations shall be protected against mechanical damage.
- Pipe-work shall be protected from physical damage.
- Mechanical connections (mechanical connectors or flared joints) shall be accessible for maintenance purposes.
- Do not install the unit in potentially explosive atmospheres

Operation

- Take care to ensure that power cable could not be pulled out or damaged during operation.
 - There is risk of fire or electric shock.
- Do not place anything on the power cable.
 - There is risk of fire or electric shock.
- Do not plug or unplug the power supply plug during operation.
 - There is risk of fire or electric shock.
- Do not touch (operate) the unit with wet hands.
 - There is risk of fire or electric shock.

- Do not place a heater or other appliances near the power cable.
 - There is risk of fire or electric shock.
- Do not allow water to run into electric parts.
 - There is risk of fire, failure of the unit, or electric shock.
- Do not store or use flammable gas or combustibles near the unit.
 - There is risk of fire or failure of unit.
- Do not use the unit in a tightly closed space for a long time.
 - It may cause damage to the unit.
- When flammable gas leaks, turn off the gas and open a window for ventilation before turning the unit on.
 - There is risk of explosion or fire.
- If strange sounds, or smell or smoke comes from unit, turn the breaker off or disconnect the power supply cable.
 - There is risk of electric shock or fire.
- Stop operation and close the window in storm or hurricane. If possible, remove the unit from the window before the hurricane arrives.
 - There is risk of property damage, failure of unit, or electric shock.
- Do not open the front cover of the unit while operation. (Do not touch the electrostatic filter, if the unit is so equipped.)
 - There is risk of physical injury, electric shock, or unit failure.
- Do not touch any electric part with wet hands. you should be power off before touching electric part.
 - There is risk of electric shock or fire.
- Do not touch refrigerant pipe and water pipe or any internal parts while the unit is operating or immediately after operation.
 - There is risk of burns or frostbite, personal injury.
- If you touch the pipe or internal parts, you should be wear protection or wait time to return to normal temperature.
 - Otherwise , it may cause burns or frostbite, personal injury.
- Turn the main power on 6 hours ago before the product starting operation.
 - Otherwise, it may cause compressor damage.

- Do not touch electric parts for 10 minutes after main power off.
 - There is risk of physical injury, electric shock.
- The inside heater of product may operate during stop mode. It is intended to protect the product.
- Be careful that some part of the control box are hot.
 - There is risk of physical injury or burns.
- When the unit is soaked (flooded or submerged), contact an Authorized Service Center.
 - There is risk of fire or electric shock.
- Be cautious that water could not be poured to the unit directly.
 - There is risk of fire, electric shock, or unit damage.
- Ventilate the unit from time to time when operating it together with a stove, etc.
 - There is risk of fire or electric shock.
- Turn the main power off when cleaning or maintaining the unit.
 - There is risk of electric shock.
- Take care to ensure that nobody could step on or fall onto the unit.
 - This could result in personal injury and unit damage.
- If the unit is not used for long time, we strongly recommend not to switch off the power supply to the unit.
 - There is risk of water freezing.
- The appliance shall be stored in a well-ventilated area where the room size corresponds to the room area as specified for operation.
- The appliance shall be stored in a room without continuously operating open flames (for example an operating gas appliance) and ignition sources (for example an operating electric heater).
- The appliance shall be stored so as to prevent mechanical damage from occurring.
- Servicing shall only be performed as recommended by the equipment manufacturer. Maintenance and repair requiring the assistance of other skilled personnel shall be carried out under the supervision of the person competent in the use of flammable refrigerants.

- When mechanical connectors are reused indoors, sealing parts shall be renewed. When flared joints are reused indoors, the flare part shall be re-fabricated.
- Periodic (more than once/year) cleaning of the dust or salt particles stuck on the heat exchangers by using water.
- Keep any required ventilation openings clear of obstruction.

CAUTION

Installation

- Always check for gas (refrigerant) leakage after installation or repair of unit.
 - Low refrigerant levels may cause failure of unit.
- Keep level even when installing the unit.
 - To avoid vibration or water leakage.
- Use two or more people to lift and transport the unit.
 - Avoid personal injury.
- Connect the water for filling or refilling the heating system as specified by EN 1717/EN 61770 to avoid contamination of drinking water by return flow.

Operation





- Do not use the unit for special purposes, such as preserving foods, works of art, etc.
 - There is risk of damage or loss of property.
- Use a soft cloth to clean. Do not use harsh detergents, solvents, etc.
 - There is risk of fire, electric shock, or damage to the plastic parts of the unit.
- Do not step on or put anything on the unit.
 - There is risk of personal injury and failure of unit.
- Use a firm stool or ladder when cleaning or maintaining the unit.
 - Be careful and avoid personal injury.

- Do not turn on the breaker or power under condition that front panel cabinet, top cover, control box cover are removed or opened.
 - Otherwise it may cause fire, electric shock, explosion or death.
- The appliance shall be disconnected from its power source during service and when replacing parts.
- Means for disconnection must be incorporated in the fixed wiring in accordance with the wiring rules.
- The Installation kit supplied with the appliance are to be used and that old Installation kit should not be reused.
- If the supply cord is damaged, it must be replaced by the manufacturer, its service agent or similarly qualified persons in order to avoid a hazard. Installation work must be performed in accordance with the national wiring standards by authorized personnel only.
- This equipment shall be provided with a supply conductor complying with the national regulation.
- The instructions for service to be done by specialized personnel, mandated by the manufacturer or the authorized representative may be supplied in only one Community language which the specialized personnel understand.
- This appliance is not intended for use by persons (including children) with reduced physical, sensory or mental capabilities or lack of experience and knowledge, unless they have been given supervision or instruction concerning use of the appliance by a person responsible for their safety. Children should be supervised to ensure that they do not play with the appliance.

INSTALLATION PART

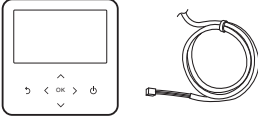
Thank you for choosing LG Electronics Air-to-Water Heat Pump **THERMAV..**

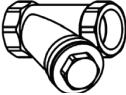
Before starting installation, please make it sure that all parts are found inside the product box.

Item	Image	Quantity
Installation Manual		1
Remote Controller / Cable		1
Water Tank Temperature Sensor		1
Strainer		1
Screw		4

GENERAL INFORMATION

With advanced inverter technology, **THERMAV**™ is suitable for applications like under floor heating, under floor cooling, and hot water generation. By Interfacing to various accessories user can customize the range of the application.

In this chapter, general information of **THERMAV**™ is presented to identify the installation procedure. Before beginning installation, read this chapter carefully and find helpful information on installation.

Model Information

Factory Model Name

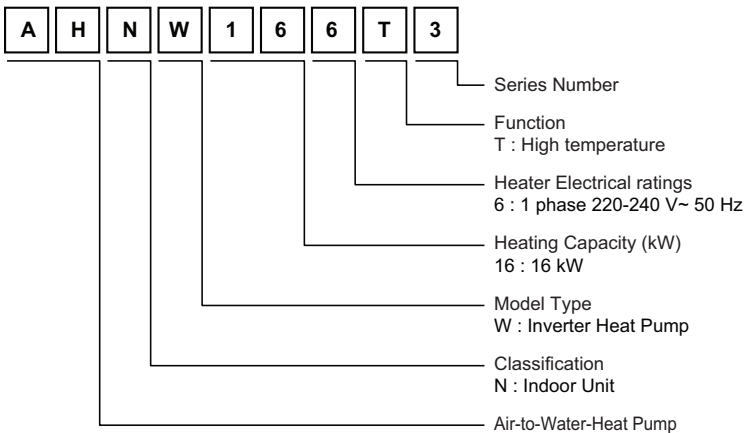
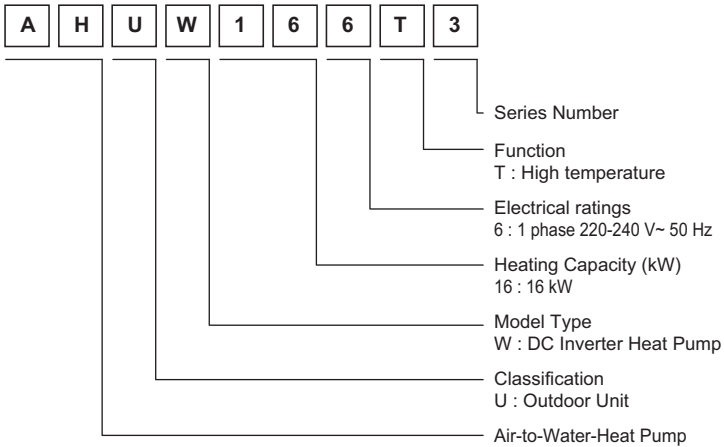

- Additional Information : serial number is refer to the barcode on the product.
- Max allowable pressure High side : 4.2 MPa / Low side : 2.4 MPa
- Refrigerant : R410A, R134a

Buyer Model Name

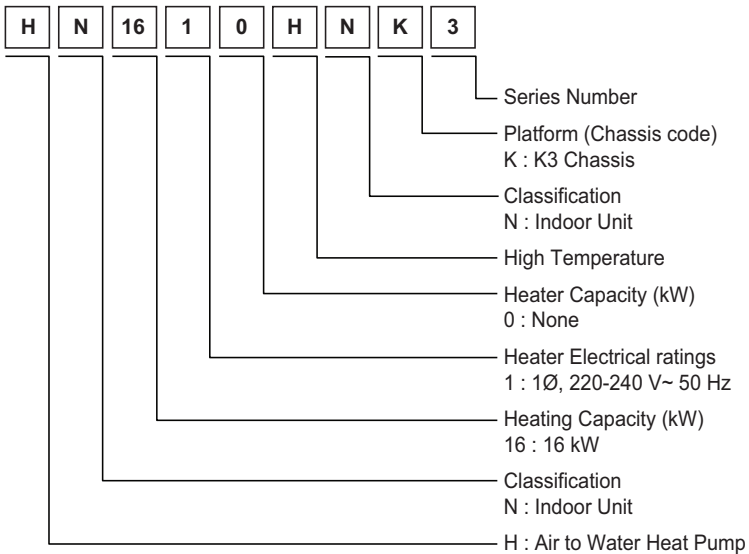
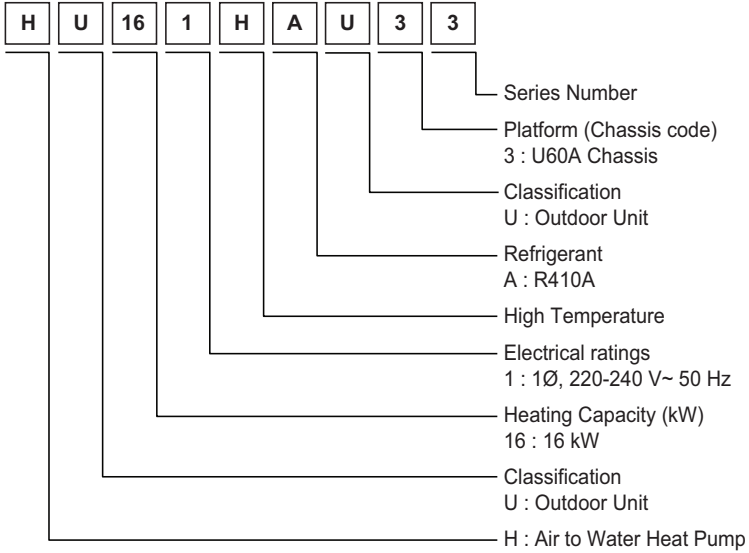

- Additional Information : serial number is refer to the barcode on the product.
- Max allowable pressure High side : 4.2 MPa / Low side : 2.4 MPa
- Refrigerant : R410A, R134a

Model name and related information

Type		Air-to water Heat Pump (For High Temperature)	
Model	Unit	Indoor	Outdoor
Power Supply		Ø, V, Hz	
		1, 220-240, 50	
Capacity	Heating	kW*1	
		16	
		kcal/h	
		13 760	
		Btu/h	
		54 600	
Net Weight		kg(lbs)	
		84(185)	89(196)
Refrigerant	Type		
			R134a
		R410A	
		Amount	kg(lbs)
		1.8(3.9)	3.8(8.3)
Sound Power Level(PWL)		dB(A)	
		63	
Maximum Running Current		A	
		20.2	
		18.9	

*1 : tested under EN14511
(water temperature 30 °C → 35 °C at outdoor ambient temperature 7 °C / 6 °C)

- All appliances were tested at atmospheric pressure.

Parts and Dimensions

Indoor unit : External

(unit : mm)

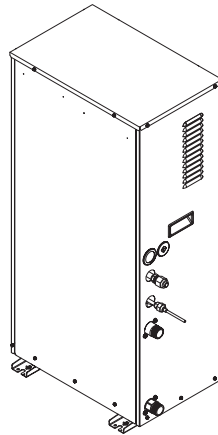
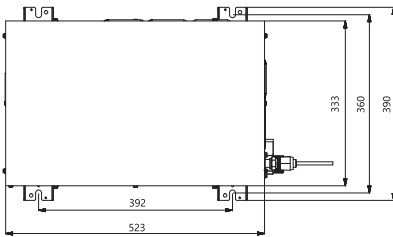
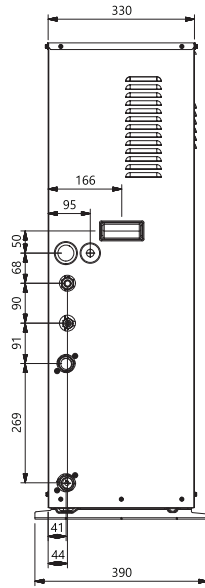
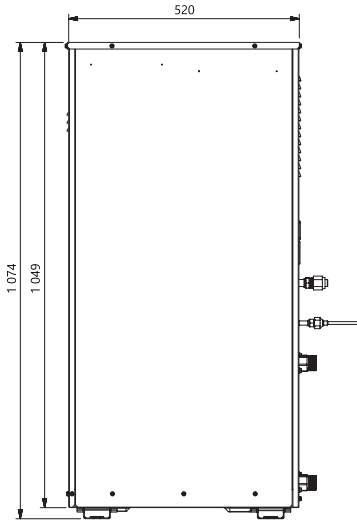

Indoor unit : Internal

(unit : mm)

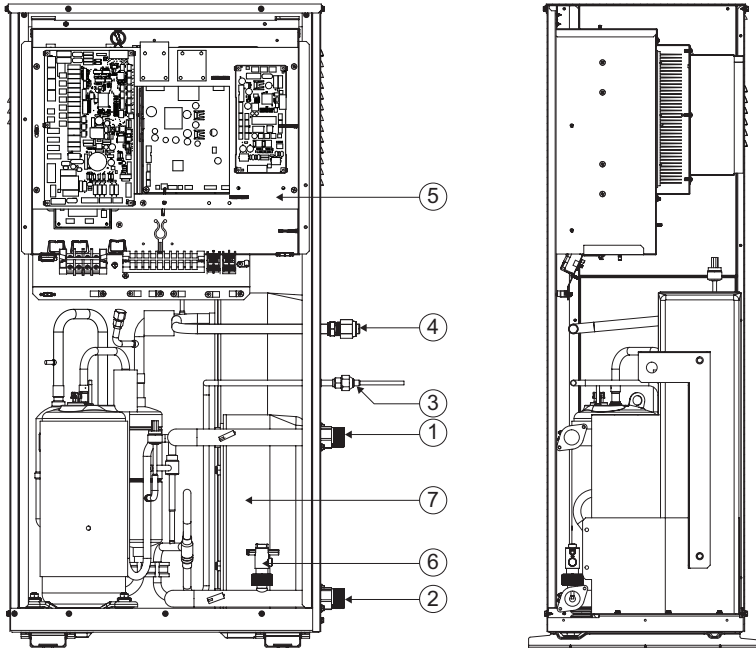

Description

No	Name	Remark
1	Leaving Water Pipe	Male PT 1 inch
2	Entering Water Pipe	Male PT 1 inch
3	Refrigerant Pipe	Ø 9.52 mm
4	Refrigerant Pipe	Ø 15.88 mm
5	Control Box	PCB and terminal blocks
6	Flow Switch	Minimum operation range at 15 LPM.
7	Plate Heat Exchanger	Heat exchange between refrigerant and water

Outdoor unit : External

Product Heating Capacity :
16 kW
U60A Chassis
(unit : mm)

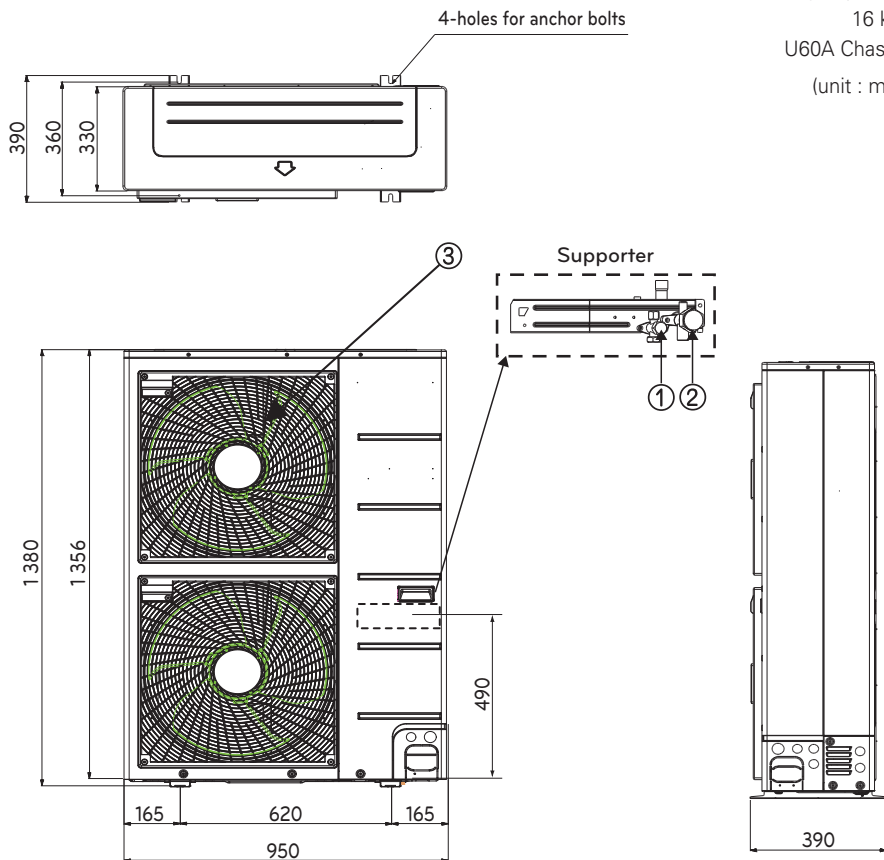

Description

No	Name
1	Liquid-side Service Valve
2	Gas-side Service Valve
3	Air discharge Grill

Control Parts

Control Box : Indoor Unit

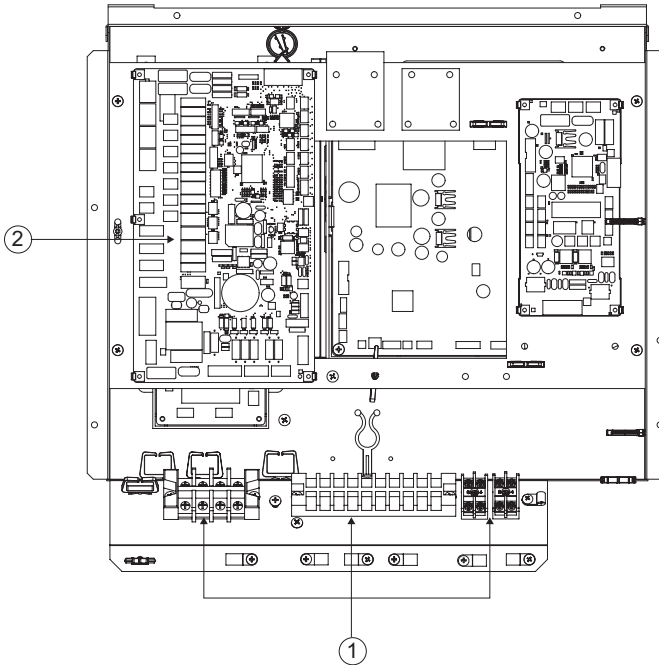

Description

No	Name	Remark
1	Terminal blocks	The terminal blocks allow easy connection of field wiring
2	Main PCB	The main PCB(Printed Circuit Board) controls the functioning of the unit

Control Panel

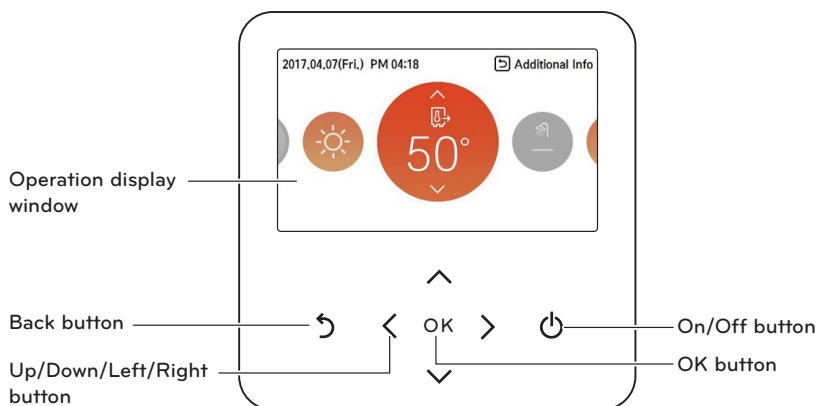

Operation display window	Operation and Settings status display
Back button	When you move to the previous stage from the menu's setting stage
Up/down/left/right button	When you change the menu's setting value
OK button	When you save the menu's setting value
On/Off button	When you turn ON/OFF the AWHP

Wiring Diagram : Indoor Unit

- Refer to the wiring diagram inside the control box.

Circuit Diagram : Indoor Unit

- Refer to the circuit diagram inside the front panel.

Wiring Diagram : Outdoor Unit

- Refer to the attached wiring diagram in the outdoor unit.

Typical Installation Example

Some installation scenes are presented for example. As these scenes are conceptual figures, installer should optimize the installation scene according to the installation conditions. Note that buffer tank should be installed.

Floor Heating only

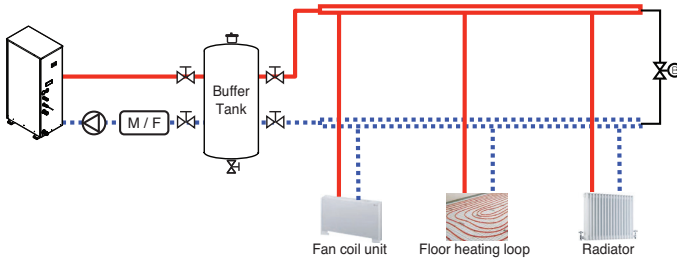

Floor Heating + Hot water

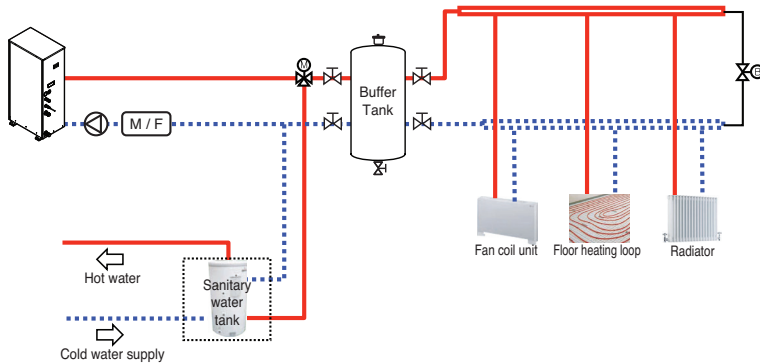

Hot water only

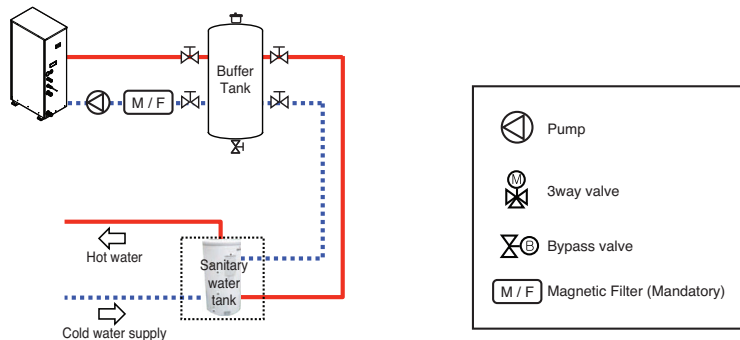

Cycle Diagram

Indoor Unit

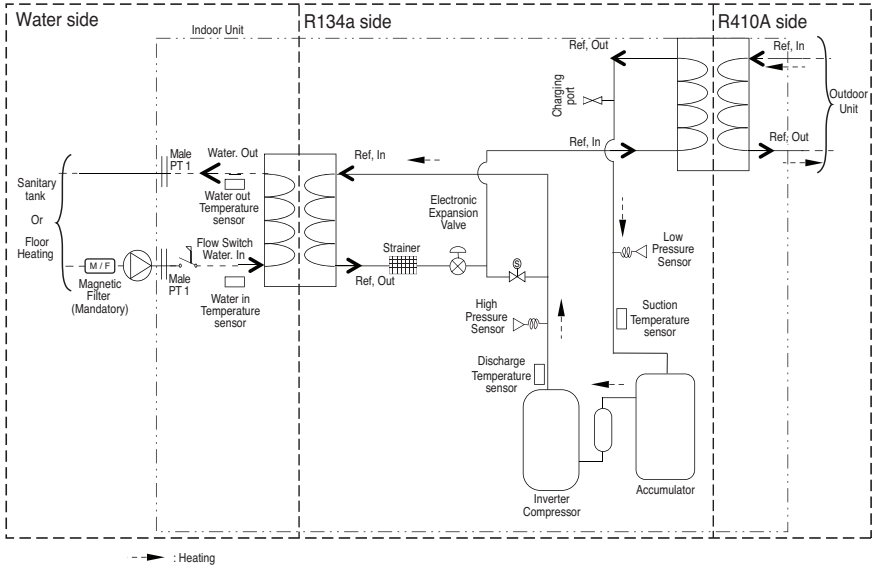

Outdoor Unit

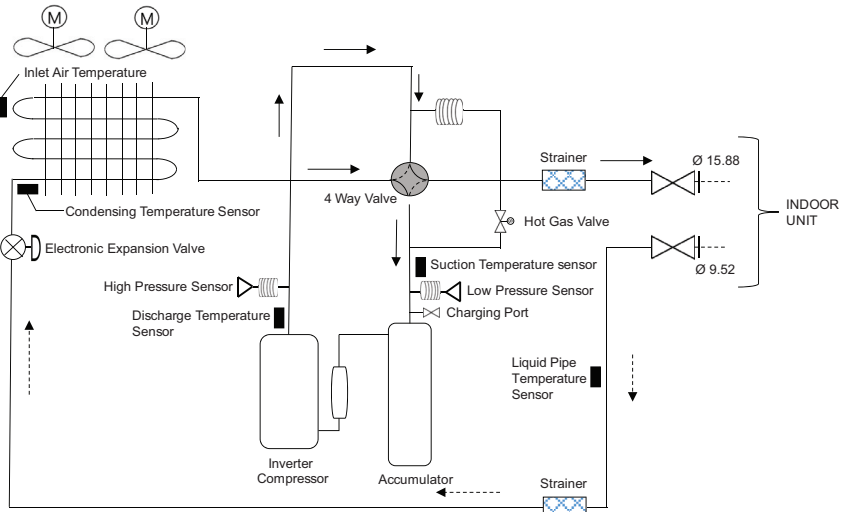

INSTALLATION

Transporting the Unit

- When carrying the suspended unit, pass the ropes between legs of base panel under the unit.
- Always lift the unit with ropes attached at four points so that impact is not applied to the unit.
- Attach the ropes to the unit at an angle (A) of 40° or less.
- Use only accessories and parts which are of the designated specification when installing.

Indoor Unit

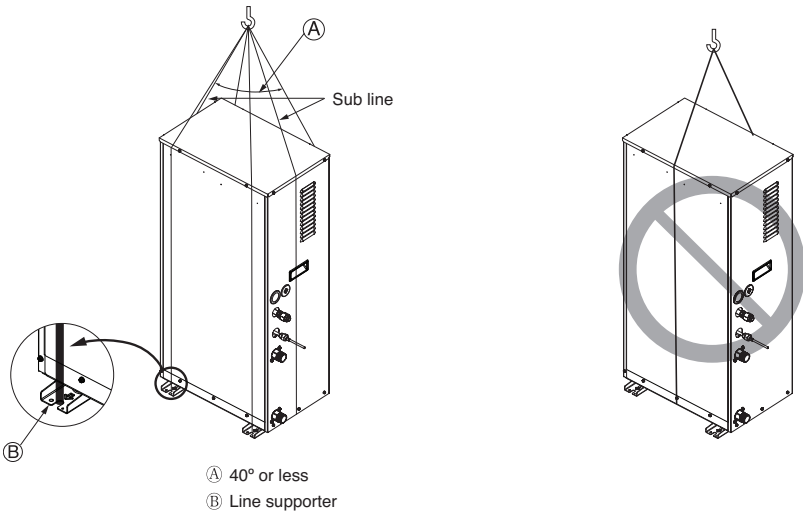

Outdoor Unit

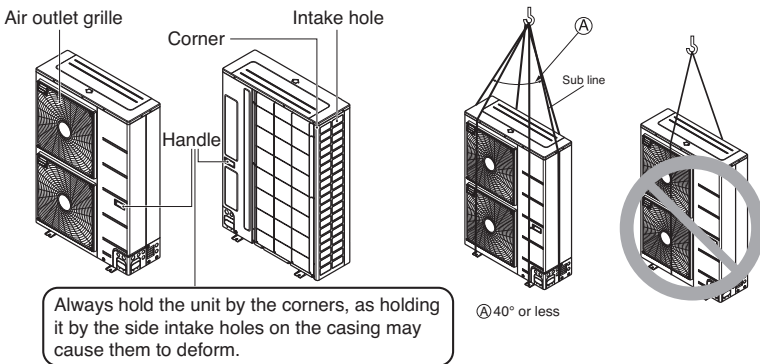

CAUTION

Be very careful while carrying the product.

- Do not have only one person carry product if it is more than 20 kg.
- PP bands are used to pack some products. Do not use them as a mean for transportation because they are dangerous.
- Do not touch heat exchanger fins with your bare hands. Otherwise you may get a cut on your hands.
- Tear plastic packaging bag and scrap it so that children cannot play with it. Otherwise plastic packaging bag may suffocate children to death.
- When carrying in Unit, be sure to support it at four points. Carrying in and lifting with 3-point support may make Outdoor Unit unstable, resulting in a fall.
- Use 2 belts of at least 8 m long.
- Place extra cloth or boards in the locations where the casing comes in contact with the sling to prevent damage.
- Hoist the unit making sure it is being lifted at its center of gravity.

Selection of the best location**Indoor**

Select space for installing Indoor Unit, which will meet the following conditions:

- The place where the unit shall be installed inside.
- The place shall easily bear a load exceeding four times of the unit weight.
- The place where the unit shall be leveled.
- The place shall allow easy water drainage.
- The place where the unit shall be connected to the outdoor unit.
- The place where the unit is not affected by an electrical noise.
- The place where there should not be any heat source or steam near the unit.

Outdoor

Select space for installing outdoor unit, which will meet the following conditions:

- No direct thermal radiation from other heat sources
- No possibility of annoying neighbors by noise from unit
- No exposition to strong wind
- With strength which bears weight of unit
- Note that drain flows out of unit when heating
- With space for air passage and service work shown next
- Because of the possibility of fire, do not install unit to the space where generation, inflow, stagnation, and leakage of combustible gas is expected.
- Avoid unit installation in a place where acidic solution and spray (sulfur) are often used.
- Do not use unit under any special environment where oil, steam and sulfuric gas exist.
- It is recommended to fence round the outdoor unit in order to prevent any person or animal from accessing the outdoor unit.
- If installation site is area of heavy snowfall, then the following directions should be observed.
- Make the foundation as high as possible.
- Fit a snow protection hood.

Select installation location considering following conditions to avoid bad condition when additionally performing defrost operation.

- Install the outdoor unit at a place well ventilated and having a lot of sunshine in case of installing the product at a place with a high humidity in winter (near beach, coast, lake, etc).
(Ex) Rooftop where sunshine always shines.
- Performance of heating will be reduced and preheat time of the indoor unit may be lengthened in case of installing the outdoor unit in winter at following location:
- Shade position with a narrow space
- Location with much moisture in neighboring floor.
- Location with much humidity around.
- Location where ventilation is good.
It is recommended to install the outdoor unit at a place with a lot of sunshine as possible as.
- Location where water gathers since the floor is not even.

When installing the outdoor unit in a place that is constantly exposed to a strong wind like a coast or on a high story of a building, secure a normal fan operation by using a duct or a wind shield.

- Install the unit so that its discharge port faces to the wall of the building.
Keep a distance 500 mm or more between the unit and the wall surface.
- Supposing the wind direction during the operation season of the air conditioner, install the unit so that the discharge port is set at right angle to the wind direction.

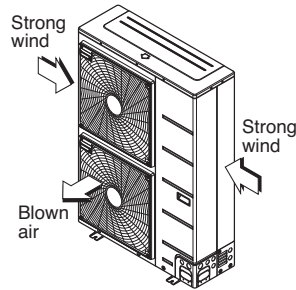
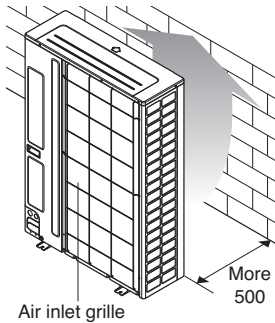

Installation Space

Indoor Unit

- The following values are the least space for installation. If any service area is needed for service according to field circumstance, obtain enough service space.
- The unit of values is mm.

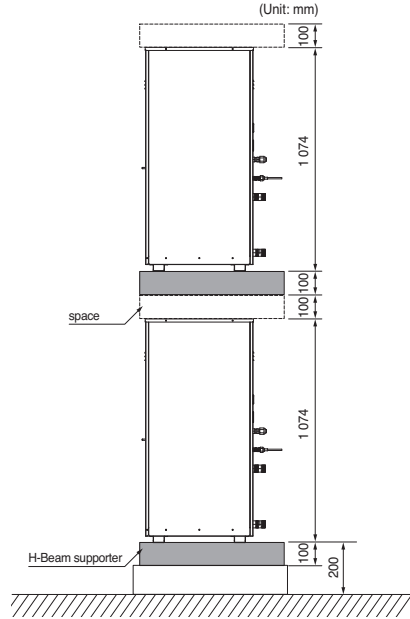
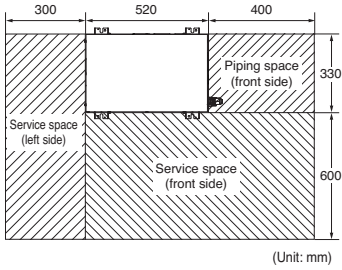

Outdoor Unit

- The following values are the least space for installation.
- If any service area is needed for service according to field circumstance, obtain enough service space.
- The unit of values is mm.

In case of obstacles on the suction side

Stand alone installation

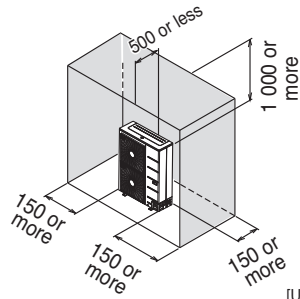
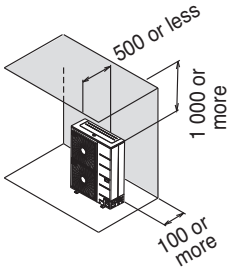
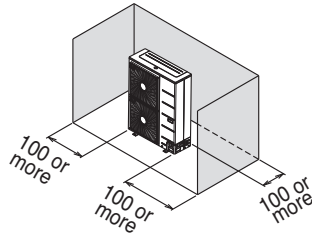
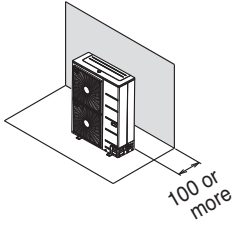

[Unit:mm]

Collective installation

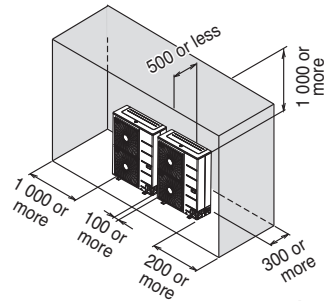
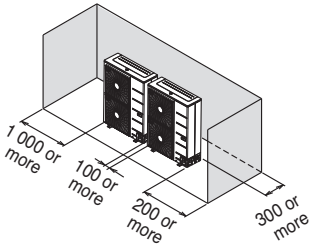

[Unit:mm]

In case of obstacles on the discharge side

Stand alone installation

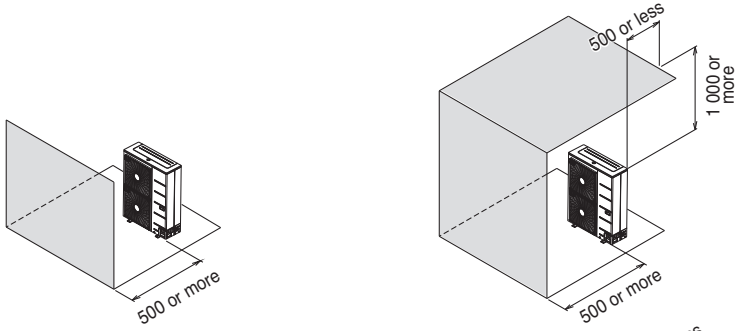

Collective installation

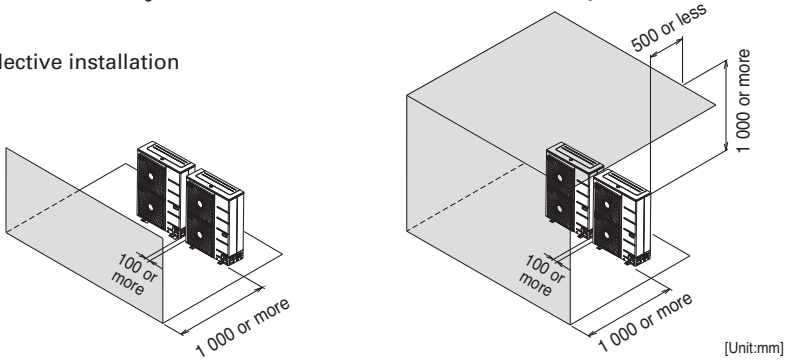

[Unit:mm]

In case of obstacles on the suction and the discharge side

⊃ Obstacle height of discharge side is higher than the unit

Stand alone installation

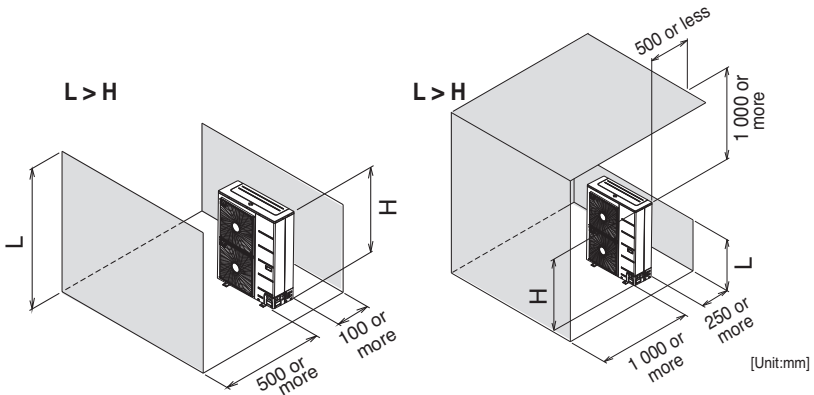

[Unit:mm]

Collective installation

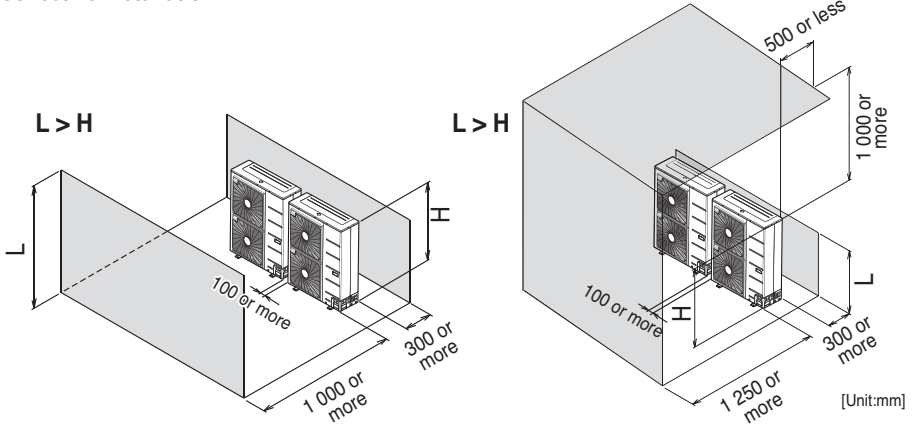

↳ Obstacle height of discharge side is lower than the unit

Stand alone installation

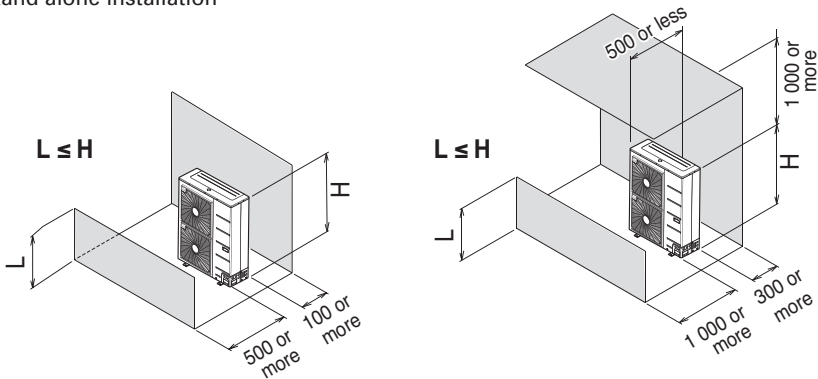

Collective installation

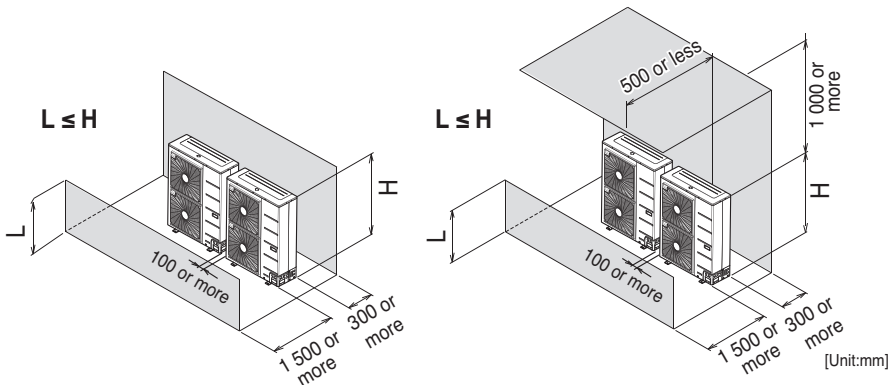

Collective / Continuous Installation for roof top use

Space required for collective installation and continuous installation: When installing several units, leave space between each block as shown below considering passage for air and people.

One row of stand alone installation

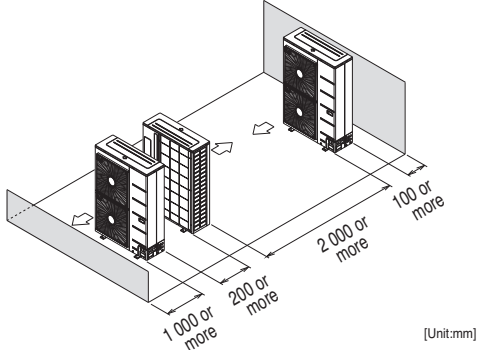

Rows of collective installation (2 or more)

- L should be smaller than H

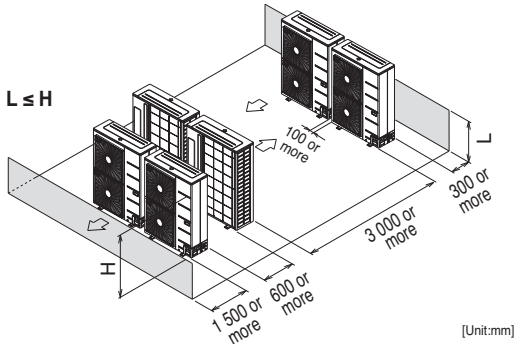

Seasonal wind and cautions in winter

- Sufficient measures are required in a snow area or severe cold area in winter so that product can be operated well.
 - Get ready for seasonal wind or snow in winter even in other areas.
 - Install a suction and discharge duct not to let in snow or rain.
 - Install the outdoor unit not to come in contact with snow directly. If snow piles up and freezes on the air suction hole, the system may malfunction. If it is installed at snowy area, attach the hood to the system.
 - Install the outdoor unit at the higher installation console by 50cm than the average snowfall (annual average snowfall) if it is installed at the area with much snowfall.
1. The height of H frame must be more than 2 times the snowfall and its width shall not exceed the width of the product. (If width of the frame is wider than that of the product, snow may accumulate)
 2. Don't install the suction hole and discharge hole of the Outdoor Unit facing the seasonal wind.

Installation at Seaside

⚠ CAUTION

- Air conditioners should not be installed in areas where corrosive gases, such as acid or alkaline gas, are produced.
- Do not install the product where it could be exposed to sea wind (salty wind) directly. It can result corrosion on the product. Corrosion, particularly on the condenser and evaporator fins, could cause product malfunction or inefficient performance.
- If outdoor unit is installed close to the seaside, it should avoid direct exposure to the sea wind. Otherwise it needs additional anticorrosion treatment on the heat exchanger.

Selecting the location(Outdoor Unit)

- If the outdoor unit is to be installed close to the seaside, direct exposure to the sea wind should be avoided. Install the outdoor unit on the opposite side of the sea wind direction.

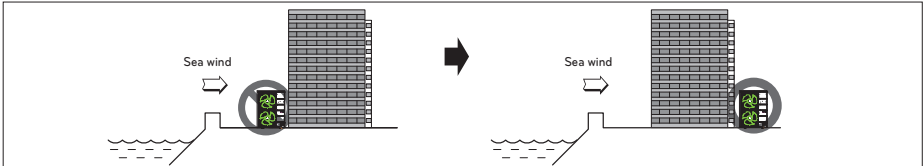

- In case, to install the outdoor unit on the seaside, set up a windbreak not to be exposed to the sea wind.

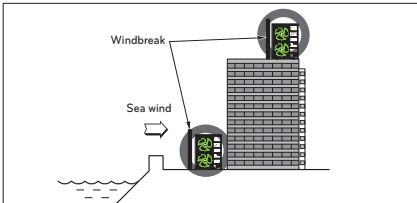

- It should be strong enough like concrete to prevent the sea wind from the sea.
- The height and width should be more than 150% of the outdoor unit.
- It should be keep more than 700 mm of space between outdoor unit and the windbreak for easy air flow.

- Select a well-drained place.

Periodic (more than once/year) cleaning of the dust or salt particles stuck on the heat exchanger by using water.

- If you can't meet above guide line in the seaside installation, please contact your supplier for the additional anticorrosion treatment.

Seasonal wind and cautions in winter

- Sufficient measures are required in a snow area or severe cold area in winter so that product can be operated well.
- Get ready for seasonal wind or snow in winter even in other areas.
- Install a suction and discharge duct not to let in snow or rain.
- Install the outdoor unit not to come in contact with snow directly. If snow piles up and freezes on the air suction hole, the system may malfunction. If it is installed at snowy area, attach the hood to the system.
- Install the outdoor unit at the higher installation console by 500 mm than the average snowfall (annual average snowfall) if it is installed at the area with much snowfall.
- Where snow accumulated on the upper part of the Outdoor Unit by more than 100 mm, always remove snow for operation.
 - The height of H frame must be more than 2 times the snowfall and its width shall not exceed the width of the product. (If width of the frame is wider than that of the product, snow may accumulate)
 - Don't install the suction hole and discharge hole of the Outdoor Unit facing the seasonal wind.

Foundation for Installation

Indoor Unit

- Fix the unit tightly with bolts as shown below so that the unit will not fall down due to earthquake.
- Noise and vibration may occur from the floor or wall since vibration is transferred through the installation part depending on installation status. Thus, use anti-vibration materials (cushion pad) fully (The base pad shall be more than 200 mm).

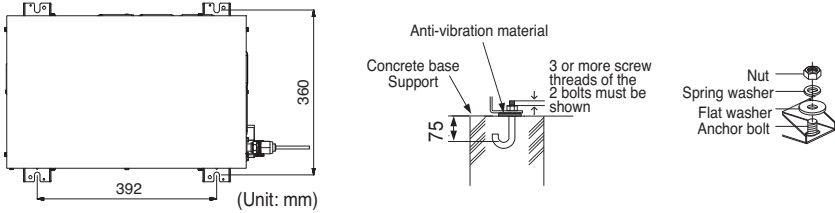

Outdoor Unit

- Check the strength and level of the installation ground so that the unit will not cause any operating vibration or noise after installation.
- Fix the unit securely by means of the foundation bolts. (Prepare 4sets of M12 foundation bolts, nuts and washers each which are available on the market.)
- It is best to screw in the foundation bolts until their length are 20mm from the foundation surface.

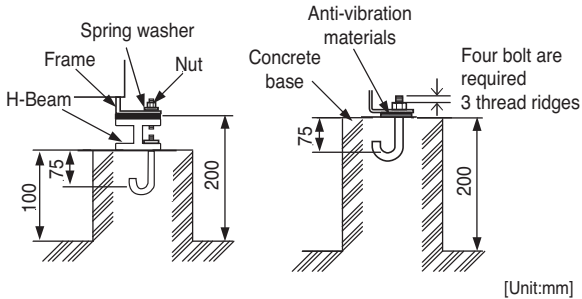

Foundation bolt executing method

INSTALLATION OF INDOOR UNIT

Electrical Wiring

Two kind of cables should be connected to the outdoor unit : One is 'Power cable', the other one is 'Connecting cable'. Power cable is a cable which is used to supply external electricity to the outdoor unit. This cable is generally connected between external power source (such as main electric power distribution panel of user's house) and the outdoor unit.

Procedure for wiring to the outdoor unit is four steps. Before starting wiring, check if wire specification is suitable and read following directions and cautions VERY carefully.

! CAUTION

The power cord connected to the outdoor unit should be complied with IEC 60245 or HD 22.4 S4 (This equipment shall be provided with a cord set complying with the national regulation.)

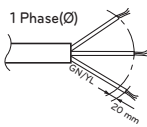

NORMAL CROSS-SECTIONAL AREA

Phase (Ø)	Capacity (kW)	Area (mm ²)
1	16	Indoor unit : 4 Outdoor unit : 6

The connecting cable connected to the outdoor unit should be complied with IEC 60245 or HD 22.4 S4 (This equipment shall be provided with a cord set complying with the national regulation.)

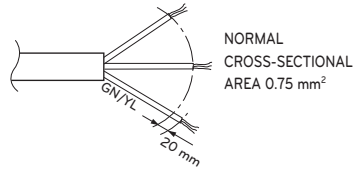

When the connection line between the indoor unit and outdoor unit is over 40 m, connect the telecommunication line and power line separately.

In order to avoid a hazard due to inadvertent resetting of the thermal cut-out, this appliance must not be supplied through an external switching device, such as a timer, or connected to a circuit that is regularly switched on and off by the utility.

If the supply cord is damaged, it must be replaced by the manufacturer, its service agent or similarly qualified persons in order to avoid a hazard.

Precautions when laying power wiring

Use round pressure terminals for connections to the power terminal block.

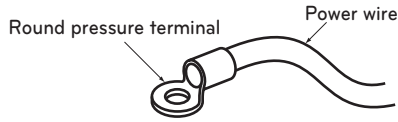

When none are available, follow the instructions below.

- Do not connect wiring of different thicknesses to the power terminal block. (Slack in the power wiring may cause abnormal heat.)
- When connecting wiring which is the same thickness, do as shown in the figure below.

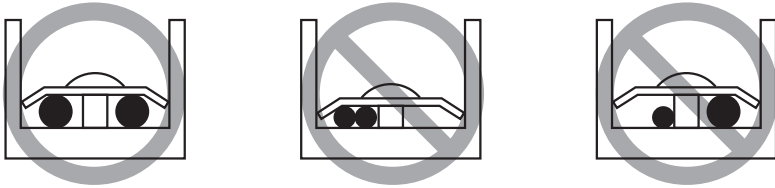

- For wiring, use the designated power wire and connect firmly, then secure to prevent outside pressure being exerted on the terminal block.
- Use an appropriate screwdriver for tightening the terminal screws. A screwdriver with a small head will strip the head and make proper tightening impossible.
- Over-tightening the terminal screws may break them.

WARNING

Make sure that the screws of the terminal are free from looseness.

Point for attention regarding quality of the public electric power supply

- European/International Technical Standard setting the limits for voltage changes, voltage fluctuations and flicker in public low-voltage supply systems for equipment with rated current ≤ 75 A.
- European/International Technical Standard setting the limits for harmonic currents produced by equipment connected to public low-voltage systems with input current ≤ 16 A or > 75 A per phase.

For 1 Phase (16 kW)

- This equipment complies with IEC (EN) 61000-3-12 in harmonic currents emission limits corresponding $R_{sc} = 33$.
- This equipment complies with reference impedance for IEC (EN) 61000-3-11.

Circuit Breaker Specification

Perform the electrical wiring work according to the electrical wiring connection.

- All wiring must comply with local requirements.
- Select a power source that is capable of supplying the current required by the air conditioner.
- Use a recognized ELCB(Electric Leakage Circuit Breaker) between the power source and the unit. A disconnection device to adequately disconnect all supply lines must be fitted.
- Model of circuit breaker recommended by authorized personnel only.

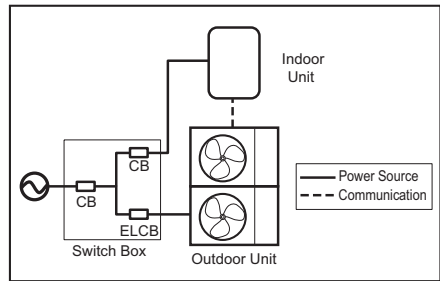

Phase (Ø)	Capacity (kW)	Maximum Running Current (A)
1	16	Indoor unit : 20.2 Outdoor unit : 18.9

PIPING AND WIRING FOR OUTDOOR UNIT

Procedures about refrigerant piping and electric wiring at the outdoor are described in this chapter. Most of procedures are similar to those of LG Air Conditioner.

Refrigerant Piping

Before starting refrigerant piping, constraints in pipe length and elevation should be examined. After resolving all constraints, some preparations are required to proceed. Then connecting pipe to the outdoor and the indoor unit is beginning.

Constraints in Pipe Length and Elevation

Phase (Ø)	Capacity (kW)	Pipe Size (mm) (Diameter : Ø)		Length A (m)		Elevation B (m)	*Additional Refrigerant (g/m)
		Gas	Liquid	Standard	Max.	Max.	
1	16	15.88	9.52	7.5	50	30	40

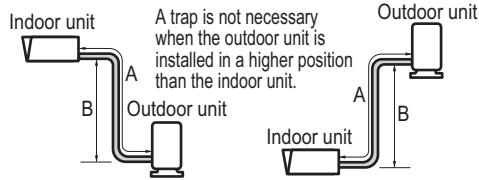

CAUTION

- Standard pipe length is 7.5 m. If the pipe length is longer than 7.5 m, additional charge of the refrigerant is required according to the table.
 - Example : If 16 kW model is installed at a distance of 50 m, 1 700 g of refrigerant should be added according to following formula : $(50-7.5) \times 40 \text{ g} = 1 700 \text{ g}$
- Rated capacity of the product is based on standard length and maximum allowable length is based on the product reliability in the operation.
- Improper refrigerant charge may result in abnormal operation.
- Pipes and wires should be purchased separately for installation of the product.

NOTE

Fill in the f-gas Label attached on outdoor about the quantity of the fluorinated greenhouse gases (This note about f-gas label may not apply depending on your product type or market.)

- Manufacturing site (See Model Name label)
- Installation site (If possible being placed adjacent to the service points for the addition or removal of refrigerant)
- The total Charge (① + ②)

Drill a Hole in the Wall

- If making a hole in the wall is required to connect pipe between the indoor unit and the outdoor unit, please follow below descriptions. Drill the piping hole with a Ø 65 mm hole core drill. Piping hole should be slightly slant to the outdoor side to prevent raindrop into indoor side.

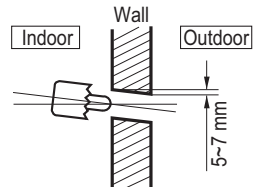

Preparation for Piping

- Main cause of gas leakage is defect in flaring work. Carry out correct flaring work in the following procedure.
- Use the de-oxidised copper as piping materials to install.

Step 1. Cut the pipes and the cable.

- Use the accessory piping kit or the pipes purchased locally.
- Measure the distance between the indoor unit and the outdoor unit.
- Cut the pipes a little longer than measured distance.
- Cut the cable 1.5 m longer than the pipe length.

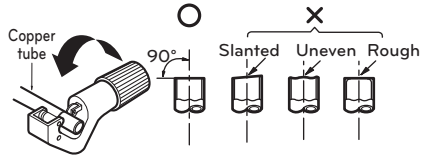

Step 2. Burrs removal

- Completely remove all burrs from the cut cross section of pipe/tube.
- Put the end of the copper tube/pipe to downward direction as you remove burrs in order to avoid to let burrs drop in the tubing.

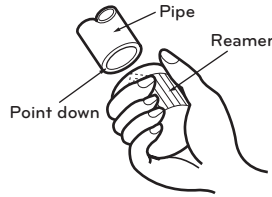

Step 3. Putting nut on

- Remove flare nuts attached to indoor and outdoor units, then put them on pipe/tube having completed burr removal. (Not possible to put them on after flaring work)

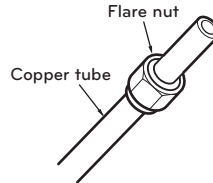

Step 4. Flaring work.

- Carry out flaring work using dedicated flaring tool for R-410A refrigerant as shown below.

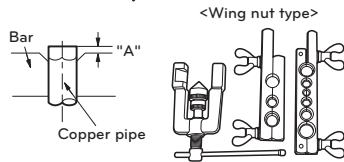

Pipe diameter [inch(mm)]	A [inch(mm)]	
	Wing nut type	Clutch type
1/4 (6.35)	0.04~0.05(1.1~1.3)	0~0.02 (0~0.5)
3/8 (9.52)	0.06~0.07(1.5~1.7)	
1/2 (12.7)	0.06~0.07(1.6~1.8)	
5/8 (15.88)	0.06~0.07(1.6~1.8)	
3/4 (19.05)	0.07~0.08(1.9~2.1)	

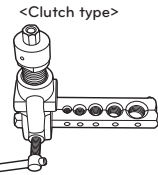

- Firmly hold copper tube in a bar(or die) as indicated dimension in the table above.

Step 5. Check

- Compare the flared work with right figure.
- If flare is seemed to be defective, cut off the flared section and do flaring work again.

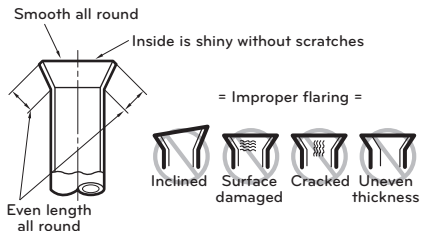

Connecting Pipe to Indoor Unit

Connecting pipe to the indoor unit is two steps. Read following directions carefully.

Step 1. Pre-tightening.

- Align the center of the pipes and sufficiently tighten the flare nut by hand.

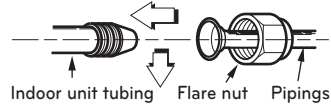

Step 2. Tightening.

- Tighten the flare nut with a wrench.
- Tightening torque is as following.

Outside diameter [mm(inch)]	Torque [kgf·m]
6.35 (1/4)	1.8 ~ 2.5
9.52 (3/8)	3.4 ~ 4.2
12.7 (1/2)	5.5 ~ 6.6
15.88 (5/8)	6.6 ~ 8.2
19.05 (3/4)	9.9 ~ 12.1

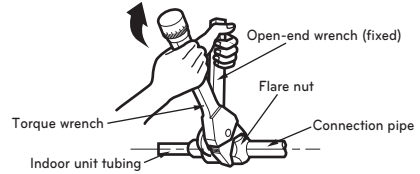

Connecting Pipe to Outdoor Unit

Connecting pipe to the outdoor unit is five steps including PCB setting.

Step 1. Determine direction of pipes.

- The pipes can be connectable in three directions.
- The directions are expressed in below figure.
- When connecting in a downward direction, knock out the knock-out hole of the base pan.

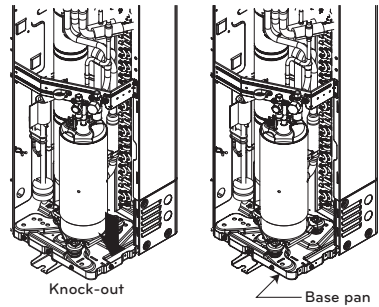
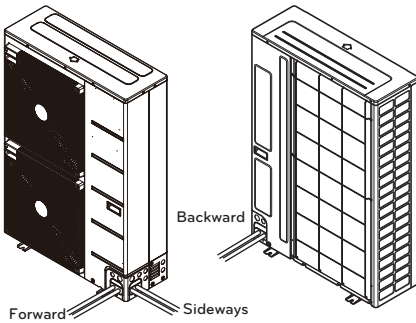

Step 2. Tightening

- Align the center of the pipes and sufficiently tighten the flare nut by hand.
- Tighten the flare nut with a wrench until the wrench clicks.
- Tightening torque is as following.

Outside diameter [mm(inch)]	Torque [kgf·m]
6.35 (1/4)	1.8 ~ 2.5
9.52 (3/8)	3.4 ~ 4.2
12.7 (1/2)	5.5 ~ 6.6
15.88 (5/8)	6.6 ~ 8.2
19.05 (3/4)	9.9 ~ 12.1

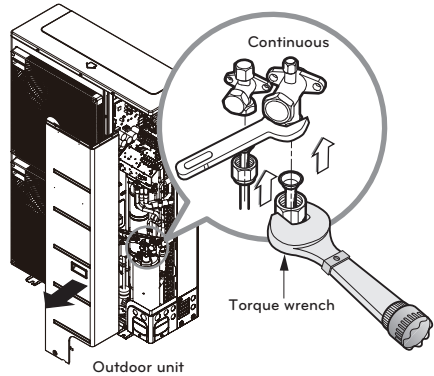

Step 3. Preventing entering of foreign objects

- Plug the pipe through-holes with putty or insulation material (procured locally) to fill up all gaps as shown in right figure.
- If insects or small animals enter the outdoor unit, it may cause a short circuit in the electrical box.
- Finally, form the pipes by wrapping the connecting portion of the indoor unit with insulation material and secure it with two kinds of vinyl tape. Ensuring thermal insulation is very important.

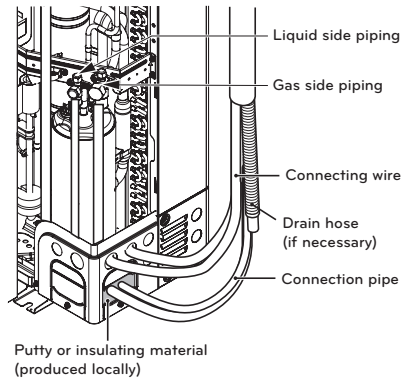

Wiring Procedure for Power Cable and Connecting Cable

Step 1. : Disassemble the side panel from the outdoor unit by loosening screws.

Step 2. : Connect Power cable to Main Power Terminal and Connecting cable to Control Terminal, respectively. See below figure for detailed information. When connecting earth cable, the diameter of cable should be bigger than 1.6 mm² to secure safety. The earth cable is connected to the terminal block where earth symbol \oplus is marked.

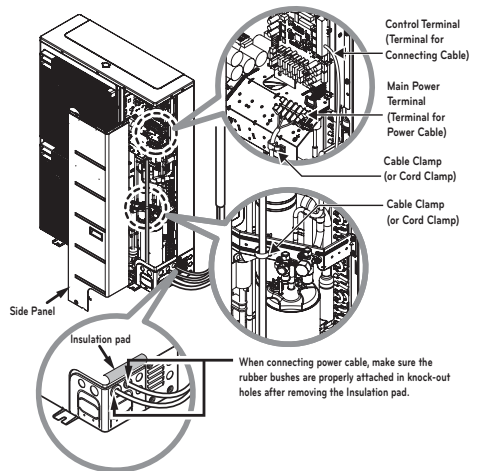

Step 3. : Use cable clamps (or cord clamps) to prevent unintended move of Power cable and Connecting cable.

Step 4. : Reassemble the side panel to the outdoor unit by fastening screws.



CAUTION

After checking and confirming following conditions, start wiring work.

- Secure dedicated power source for the Air-to-Water heat pump. The wiring diagram (attached inside the control box of the indoor unit) is presenting related information.
- Install a circuit breaker switch between power source and the outdoor unit.
- Although it is very rare case, sometimes the screws used to fasten internal wires can be loosen due to the vibration while product transportation. Check these screws and make it sure if they are all fastened tightly. If not tightened, burn-out of the wire can be occurred.
- Check the specification of power source such as phase, voltage, frequency, etc.
- Confirm that electrical capacity is sufficient.
- Be sure that the starting voltage is maintained at more than 90 percent of the rated voltage marked on the name plate.
- Confirm that the cable thickness is as specified in the power sources specification. (Particularly note the relation between cable length and thickness.)
- Provide an ELB(electric leakage breaker) when the installation place is wet or moist.
- The following troubles would be caused by abnormal voltage supply such as sudden voltage increasing or voltage drop-down.
 - Chattering of a magnetic switch. (frequent on and off operation.)
 - Physical damage of parts where magnetic switch is contacted.
 - Break of fuse.
 - Malfunction of overload protection parts or related control algorithms.
 - Failure of compressor start up.
- Ground wire to ground outdoor unit to prevent electrical shock.

CAUTION

The Power cord connected to the unit should be selected according to the following specifications.

Finalizing

After pipes are connected and electric cables are wired, pipe forming and some tests are remained. Especially, careful attention is required while proceeding leakage test because the leakage of the refrigerant effects degrade of performance directly. Also, it is very hard to find leaked point after all installation procedures are finished.

Pipe Forming

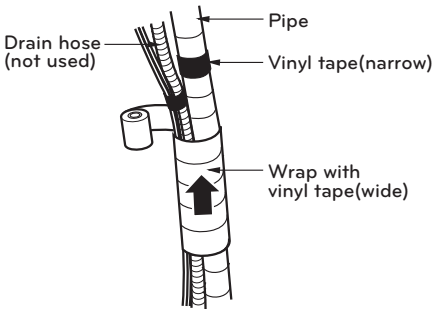

Do pipe forming by wrapping the connecting cable and refrigerant pipe (between the indoor unit and outdoor unit) with thermal insulation material and secure it with two kinds of vinyl tape.

- Tape the refrigerant pipe, power cable and connecting cable from down to up.
- Secure the taped pipe is along with the exterior wall. Form a trap to prevent water entering the room and electrical part.
- Fix the taped pipe onto the wall by saddle or equivalent.

Taping Procedure

- Tape the pipes, connecting cable and power cable from down to up. If taping direction is up to down, rain drop may be sinking into the pipes or cables.
- Secure the taped pipe along the exterior wall using saddle or equivalent.
- Trap is required to prevent water from entering into electrical parts.

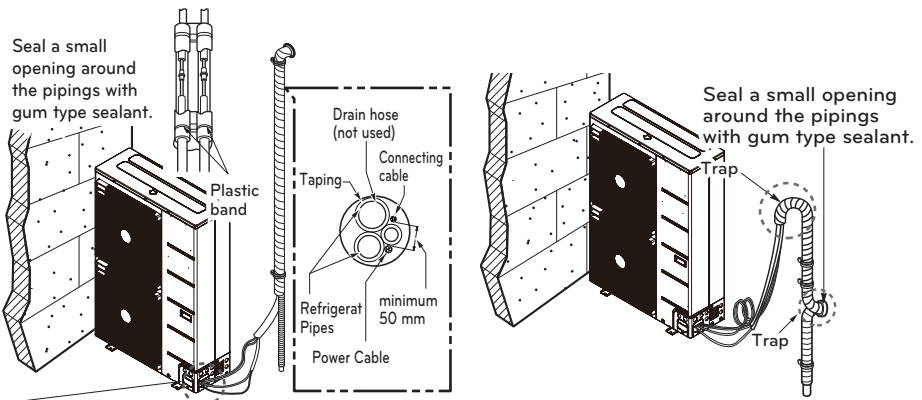

- Trap is required to prevent water from entering into electrical parts.

Leakage test and Evacuation

Air and moisture remaining in the refrigerant system have undesirable effects as indicated below.

- Pressure in the system rises.
- Operating current rises.
- Cooling(or heating) efficiency drops.
- Moisture in the refrigerant circuit may freeze and block capillary tubing.
- Water may lead to corrosion of parts in the refrigeration system.

Therefore, the indoor/outdoor unit and connecting tube must be checked for leak tight, and vacuumed to remove incondensable gas and moisture in the system.

Preparation

- Check that each tube(both liquid and gas side tubes) between the indoor and outdoor units have been properly connected and all wiring for the test run has been completed. Remove the service valve caps from both the gas and the liquid side on the outdoor unit. Check that both the liquid and the gas side service valves on the outdoor unit are kept closed at this stage.

Leakage test

- Connect the manifold valve(with pressure gauges) and dry nitrogen gas cylinder to this service port with charge hoses.

! CAUTION

Be sure to use a manifold valve for leakage test. If it is not available, use a stop valve for this purpose. The "Hi" knob of the manifold valve must always be kept close.

- Pressurize the system to no more than 3.0 Mpa with dry nitrogen gas and close the cylinder valve when the gauge reading reached 3.0 Mpa. Next, test for leaks with liquid soap.

To avoid nitrogen entering the refrigerant system in a liquid state, the top of the cylinder must be higher than its bottom when you pressurize the system. Usually, the cylinder is used in a vertical standing position.

- Do a leakage test of all joints of the tubing(both indoor and outdoor) and both gas and liquid side service valves. Bubbles indicate a leak. Be sure to wipe off the soap with a clean cloth
- After the system is found to be free of leaks, relieve the nitrogen pressure by loosening the charge hose connector at the nitrogen cylinder. When the system pressure is reduced to normal, disconnect the hose from the cylinder.

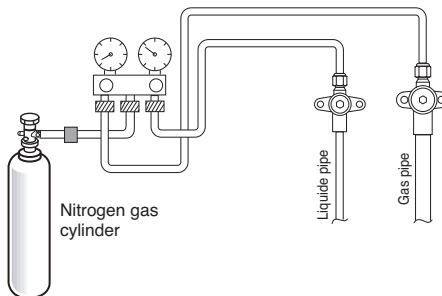

Evacuation

- Connect the charge hose end described in the preceding steps to the vacuum pump to evacuate the tubing and indoor unit. Confirm the "Lo and Hi" knob of the manifold valve is open. Then, run the vacuum pump. The operation time for evacuation varies with tubing length and capacity of the pump. The following table shows the time required for evacuation.

Required time for evacuation when 0.11 m ³ /h vacuum pump is used	
If tubing length is less than 10 m	If tubing length is longer than 10 m
30 min. or more	60 min. or more
0.1 kPa or less	

- When the desired vacuum is reached, close the "Lo and Hi" knob of the manifold valve and stop the vacuum pump.

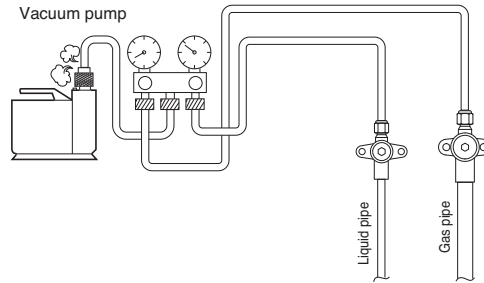

Finishing the job

- With a service valve wrench, turn the valve stem of liquid side valve counter-clockwise to fully open the valve.
- Turn the valve stem of gas side valve counter-clockwise to fully open the valve.
- Loosen the charge hose connected to the gas side service port slightly to release the pressure, then remove the hose.
- Replace the flare nut and its bonnet on the gas side service port and fasten the flare nut securely with an adjustable wrench. This process is very important to prevent leakage from the system.
- Replace the valve caps at both gas and liquid side service valves and fasten them tight. This completes air purging with a vacuum pump. The air conditioner is now ready to test run.

Electrical Wiring

General Consideration

Followings are should be considered before beginning indoor unit wiring.

- Field-supplied electrical components such as power switches, circuit breakers, wires, terminal boxes, etc should be properly chosen with compliance with national electrical legislation or regulation.
- Make it sure that supplied electricity is enough to operate the product including outdoor unit, electric heater, water tank heater, etc. The capacity of fuse also selected according to the power consumption.
- The main electricity supply should be dedicated line. Sharing main electricity supply with other devices such as washing machine or vacuum cleaner is not permitted.



CAUTION

- Before starting wiring job, the main electricity supply should be turned off until wiring is completed.
- When adjusting or changing wiring, the main electricity supply should be turned off and ground wire should be connected securely.
- Installation place should be free from the attack of wild animal. For example, mice's wire attacking or frog's entering into the indoor unit may cause critical electrical accident.
- All power connections should be protected from dew condensation by thermal insulation.
- All electrical wiring should comply with national or local electrical legislation or regulation.
- The ground should be connected exactly. Do not earth the product to the copper pipe, steel fence at the veranda, city water outlet pipe, or any other conductivity materials.
- Fix all cable using cord clamp tightly. (When cable is not fixed with cord clamp, use additionally supplied cable ties.)
- Pipes and wires should be purchased separately for installation of the product.

Terminal Block Information

Symbols used below pictures are as follows :

- L, L1, L2 : Live (230 V AC)
- N : Neutral (230 V AC)
- BR : Brown , WH : White , BL : Blue , BK : Black

Terminal Block 1



Power supply for Indoor unit Earth

Terminal Block 2

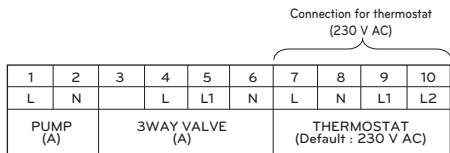

Connection for Main Pump Water flow switching between under floor heating and DHW tank heating.

Terminal Block 3

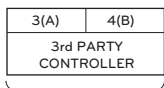

Connection for 3rd Party controller

Terminal Block 4

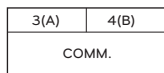

Connection for Indoor unit communication

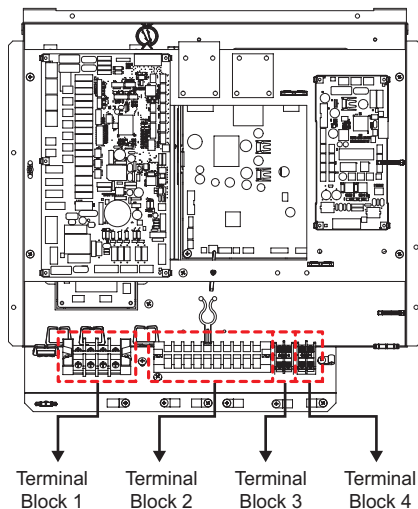

Terminal Block 1 Terminal Block 2 Terminal Block 3 Terminal Block 4

⚠ CAUTION

You should separate the communication wiring, in case of communication wiring length is over 40 M.

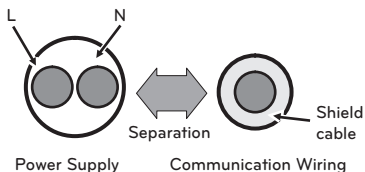

How to connect wirings

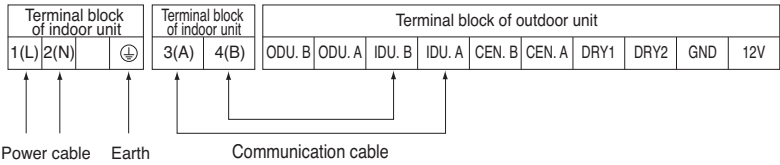
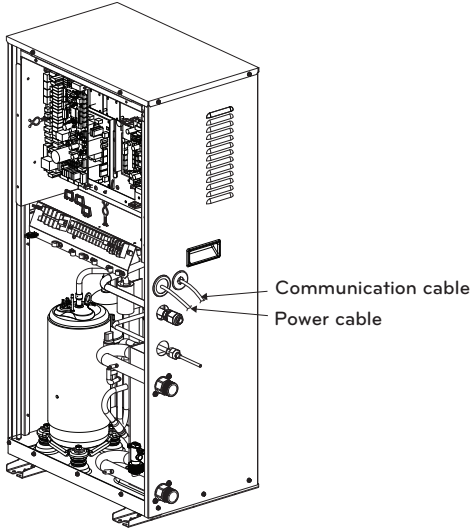

- When connecting the power cable, be sure to fix the double sheathed power cable to the clamp cord.

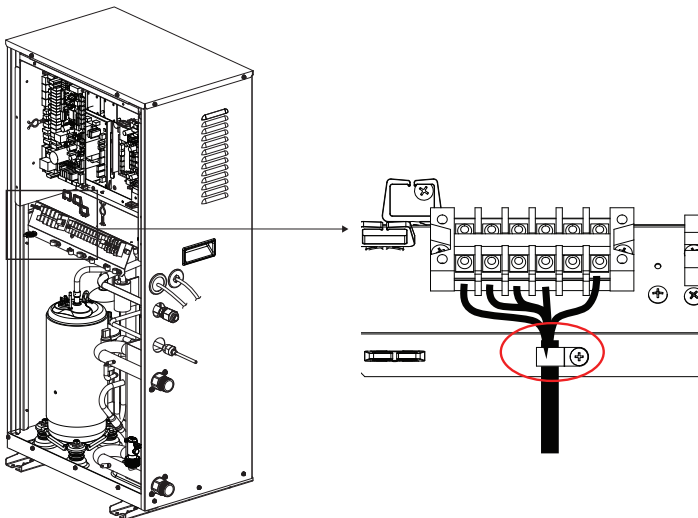

PIPING AND WIRING FOR INDOOR UNIT

Procedures about water piping and electric wiring at the indoor unit are described in this chapter. Water piping and water circuit connection, water charging, pipe insulations will be shown for water piping procedures. For wiring, terminal block connection, connecting with the outdoor unit, electric heater wiring will be introduced. Accessories connection, such as sanitary water tank, thermostat, 3way or 2way valves, etc will be dealt in separated chapter.

Water Piping and Water Circuit Connection

CAUTION

General Considerations

Followings are should be considered before beginning water circuit connection.

- Service space should be secured.
- Water pipes and connections should be cleaned using water.
- Space for installing external water pump should be provided if internal water pump capacity is not enough for installation field.
- Never connect electric power while proceeding water charging.

Water Piping and Water Circuit Connection

Definition of terms are as follow :

- Water piping : Installing pipes where water is flowing inside the pipe.
- Water circuit connecting : Making connection between the product and water pipes or between pipes and pipes. Connecting valves or elbows are, for example, in this category.

While installing water pipes, followings should be considered :

- While inserting or putting water pipes, close the end of the pipe with pipe cap to avoid dust entering.
- When cutting or welding the pipe, always be careful that inner section of the pipe should not be defective. For example, no weldments or no burrs are found inside the pipe.
- Drain piping should be provided in case of water discharge by the operation of the safety valve. This situation can be happened when the internal pressure is over 3.0 bar and water inside the indoor unit will be discharged to drain hose.

While connecting water pipes, followings should be considered.

- Pipe fittings (e.g. L-shape elbow, T-shape tee, diameter reducer, etc) should be tightened strongly to be free from water leakage.
- Connected sections should be leakage-proof treatment by applying tefron tape, rubber bushing, sealant solution, etc.
- Appropriate tools and tooling methods should be applied to prevent mechanical breakage of the connections.
- Operation time of flow control valve(e.g. 3way valve or 2way valve) should be less than 90 seconds.
- Drain hose should be connected with drain piping.

Water Charging

For water charging, please follow below procedures.

- Step 1.** Open all valves of whole water circuit. Supplied water should be charged not only inside the indoor unit, but also in the under floor water circuit, sanitary water tank circuit, FCU water circuit, and any other water circuits controlled by the product.
- Step 2.** Connect supply water into drain valve and fill valve located at the side of the shut-off valve.



CAUTION

No water-leakage permitted at the drain and fill valve. Leakage-proof treatment which is described in previous section should be applied.

- Step 3.** Start to supply water. While supplying water, following should be kept.
- Pressure of supplying water should be 2.0 bar approximately.
 - For supplying water pressure, time to be taken from 0 bar to 2.0 bar should be more than 1 minute. Sudden water supply can yield water drain through safety valve.
 - Fully open the cap of air vent to assure air purging. If air is exist inside the water circuit, then performance degrade, noise at the water pipe, mechanical damage at the surface of electric heater coil.
- Step 4.** Stop water supplying when the pressure gauge located in front of the control panel indicates 2.0 bar.
- Step 5.** Close drain valve and fill valve. Then wait for 20~30 seconds to observe water pressure being stabilized.
- Step 6.** If following conditions are satisfactory, then go to step 7(pipe insulation). Otherwise, go to step 3.
- Pressure gauge indicates 2.0 bar. Note that sometimes pressure in decreased after step 5 due to water charging inside expansion vessel.
 - No air purging sound is heard or no water drop are popping out from air vent.

Pipe Insulation

Purpose of water pipe insulation is :

- To prevent heat loss to external environment
- To prevent dew generation on the surface of the pipe in cooling operation

Water cycle

* For the water pipe system, use the closed loop type.

1. For the parts of the water pipe system, use the parts above the design water pressure.
2. For the water pipe, do not use steel pipe.
3. To replace the connected device easily, install the union joint (2).
4. Install the service port (3) to clean the heat exchanger at each inlet and outlet of the water pipe.
5. Always install a strainer (4) at the inlet of the water pipe.
 - For the strainer, use one with 28 mesh or above with measurement diameter of 0.4mm or less. (Exclude other net)
 - Always install the strainer on the horizontal pipe.
(When dirt, trash, rusted pieces get into the water pipe system, it can cause problems to the product by corroding the metallic material.)

6. Install the air vent (5) at the top of the water pipe.
7. Install a thermometer (6) and pressure gauge (7) at the inlet and outlet of the water pipe.
8. Install the drain valve (8) that can be used for draining the water inside when replacing the part or providing service.
9. Install the shut-off valve (9) to block the water by closing the valve when replacing the part or cleaning.
10. Apply insulated treatment on the exterior of the water pipe so that water drops do not form.
11. Install excessive pressure safety valve (10) that meets the design water pressure to prevent unit or water pipe damage at the pressure increase inside the water pipe system.
12. Always install a Magnetic Filter(11) at the inlet of the water pipe.

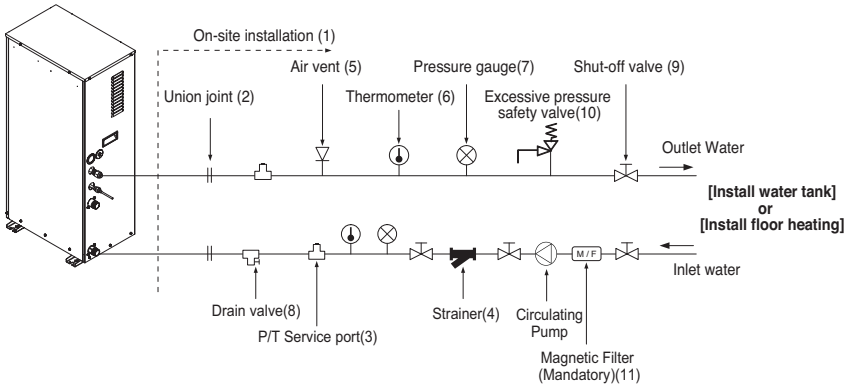

13. There is a drain hole at the bottom of prevent risk of electric shock caused by leakage of water.

*** Water tank & floor heating installation**

1. Use the pump (1) with sufficient capacity to assure loss of overall water pressure and to supply water to the Indoor Unit.
2. Install the shut-off valve (2) on both sides of the pump to clean and repair the pump.
3. Install the flexible joint (3) to prevent noise and vibration transferred from the pump.
4. Install the pressure gauge (4) to monitor the water pressure from water tank. (Option)
5. Install the expansion tank (5) to accommodate the water contracted or expanded from the temperature difference and to supply the water.
6. After the installation of water pipe system is completed, open the water supply valve (6) and supply the water.
7. When installing the water tank, insert the water tank temperature sensor (7) to measure the temperature of the water inside the tank.
 - For the water tank temperature sensor, use the sensor supplied on the product.
 - When heating the floor, measure the temperature by using the remote controller or remote temperature sensor (Separately sold).
8. Use the water tank (9) with the heat exchange coil (8) installed so that the heat can be exchanged sufficiently inside the tank.

Installation of water tank

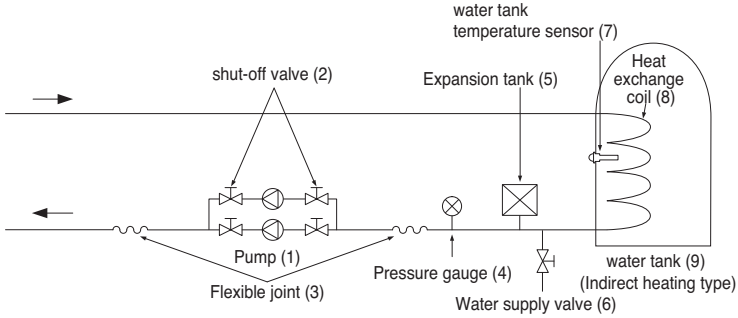

Installation of floor heating

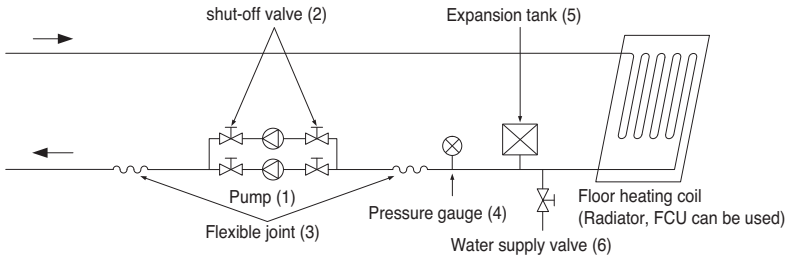

Strainer

- Use the 28 mesh strainer. (Exclude scale diameter of 0.4 mm or less and other net)
- Check the strainer direction and assemble on the inlet hole (Refer to picture)
- Wrap the Teflon tape on the screw thread of the water pipe for more than 15 times for assembly.
- Install the service port facing downward. (Within left/right 45 degrees)
- Check if there is any leakage on the connecting part.
- Clean the strainer periodically. (Once a year or more frequent)

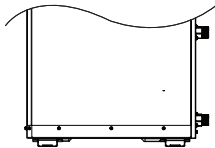

Front

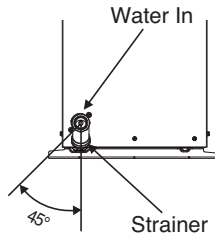

Side

Water pump Capacity

The water pump is variable type which is capable to change flow rate, so it may be required to change default water pump capacity in case of noise by water flow. In most case, however, it is strongly recommended to set capacity as Maximum.

NOTE

- To secure enough water flow rate, do not set water pump capacity as Minimum. It can lead unexpected flow rate error CH14.

Water Quality

Water quality should be complied with EN 98/83 EC Directives. Detailed water quality condition can be found in EN 98/83 EC Directives.

CAUTION

- If the product is installed at existing hydraulic water loop, it is important to clean hydraulic pipes to remove sludge and scale.
- Installing sludge strainer in the water loop is very important to prevent performance degrade.
- Chemical treatment to prevent rust should be performed by installer.
- It is strongly recommended to install an additional filter on the heating water circuit. Especially to remove metallic particles from the heating piping, it is advised to use a magnetic or cyclone filter, which can remove small particles. Small particles may damage the unit and will NOT be removed by the standard filter of the heat pump system.
- Water quality check should be implemented before completing the installation of system. Detailed guide can be found in the table as below.

Water contents	Value			
pH	7.5~9.0			
Conductivity	10~500 uS/cm			
TDS (Total dissolved solids)	8~400 ppm			
Alkalinity (HCO ₃)	60~300 (mg/L)			
Total hardness	4 ~ 8.5 °dH			
	71.4 ~ 151.7 (mg/L)			
Iron (Fe)	≤ 0.2 (mg/L)			
Sulphate (SO ₄ ²⁻)	≤ 100 (mg/L)			
Nitrite (NO ₃)	≤ 100 (mg/L)			
Free chlorine (Cl ₂)	≤ 1 (mg/L)			
Chlorides (Cl ⁻)	ppm	ST3316	ST3304	
		ST3316	ST3304	
	pH7	15 °C	3 000	180
		40 °C	500	50
		60 °C	200	30
		80 °C	125	20
	pH9	15 °C	18 000	700
		40 °C	2 600	250
60 °C		1 000	170	
80 °C		550	130	

Frost protection

In areas of the country where entering water temperatures drop below 0 °C, the water pipe must be protected by using an approved antifreeze solution. Consult your AWHP unit supplier for locally approved solutions in your area. Calculate the approximate volume of water in the system. (Except the AWHP unit.) And add six liters to this total volume to allow for the water contained in AWHP unit.

Antifreeze type	Antifreeze mixing ratio					
	0 °C	-5 °C	-10 °C	-15 °C	-20 °C	-25 °C
Ethylene glycol	0 %	12 %	20 %	30 %	-	-
Propylene glycol	0 %	17 %	25 %	33 %	-	-
Methanol	0 %	6 %	12 %	16 %	24 %	30 %

If you use frost protection function, change DIP switch setting and input the temperature condition in Installation mode of remote controller. Refer to page 109 and 161.



CAUTION

- Use only one of the above antifreeze.
- If a antifreeze is used, pressure drop and capability degradation of the system can be occurred.
- If one of antifreezes is used, corrosion can be occurred. So please add corrosion inhibitor.
- Please check the concentration of the antifreeze periodically to keep same concentration.
- When the antifreeze is used (for installation or operation), take care to ensure that antifreeze must not be touched.
- Ensure to respect all laws and norms of your country about Anti-freeze usage.

ACCESSORIES INSTALLATION

THERMAV. can interface to various accessories to extend its functionality and to improve user convenience. In this chapter, specifications about supported 3rd party accessories and how to connect to **THERMAV.** is introduced.

It is noted that this chapter only deal with 3rd party accessories. For accessories supported by LG Electronics, please refer to installation manual of each accessories.

Accessories supported by LG Electronics

Item	Purpose	Model
Remote Air Sensor	To control by air temperature	PQRSTA0
Dry Contact	To receive on & off external signal	PDRYCB000
	Dry Contact For Thermostat	PDRYCB300
DHW Tank (Single Heating Coil)	To generate and store hot water	OSHW-200F : 200L OSHW-300F : 300L OSHW-500F : 500L
DHW Tank (Double Heating Coil)		OSHW-300FD : 300L
Thermistor for DHW Tank	To control hot water temperature of DHW tank	PHRSTA0
Meter Interface	To measure production / consumption power	PENKTH000
Central Controller	Multiple installed products into one central control	
Wi-Fi Modem	To enable remote system operation from smartphone	PWFMD200
Wi-Fi Extension cable	To connect Wi-Fi Modem with Indoor PCB for communication	PWYREW000
Extension wire	To connect remote controller with Indoor PCB for communication	PZCWRC1
Wired Remote Controller	To install two remote controllers on unit with 2-remo cable	PREMTW101

Accessories supported by 3rd party Companies

Item	Purpose	Specification
Thermostat	To control by air temperature	Heating-Only type (230 V AC) Cooling/Heating type (230 V AC with Mode selection switch)
3 rd Party Controller	To connect external controller using modbus protocol	
3way valve and actuator	(A) : To control water flow for hot water heating or floor heating / To control water flow when installing 3rd party boiler (B) : To control close/open mode of solar circuit	3 wire, SPDT (Single Pole Double Throw) type, 230 V AC
External Pump	To retain sufficient capacity using additional pump	
Smart Grid	To control operation mode depending on input signal from provider	

Before Installation

WARNING

Followings should be kept before installation

- Main power must be turned off during installing 3rd party accessories.
- 3rd party accessories should be comply with supported specification.
- Proper tools should be chosen for installation.
- Never do installation with wet hands.

Thermostat

Thermostat is generally used to control the product by air temperature. When thermostat is connected to the product, the product operation is controlled by the thermostat.

Installation condition

CAUTION

- USE 220-240 V~ Thermostat
- Some electro-mechanical type thermostat has internal delay time to protect compressor. In that case, mode change can takes time more than user's expectation. Please read thermostat manual carefully if the unit does not response quickly.
- Setting temperature range by thermostat can be different with that of the unit. The heating or cooling set temperature should be chosen within the setting temperature range of the unit.
- It is highly recommended that the thermostat should be installed where space heating is mainly applied.

Following location should be avoid to secure proper operation :

- Height from floor is approximately 1.5 m.
- Thermostat can not be located where the area may be hidden when door is open.
- Thermostat can not be located where external thermal influence may be applied. (such as above heating radiator or open window)

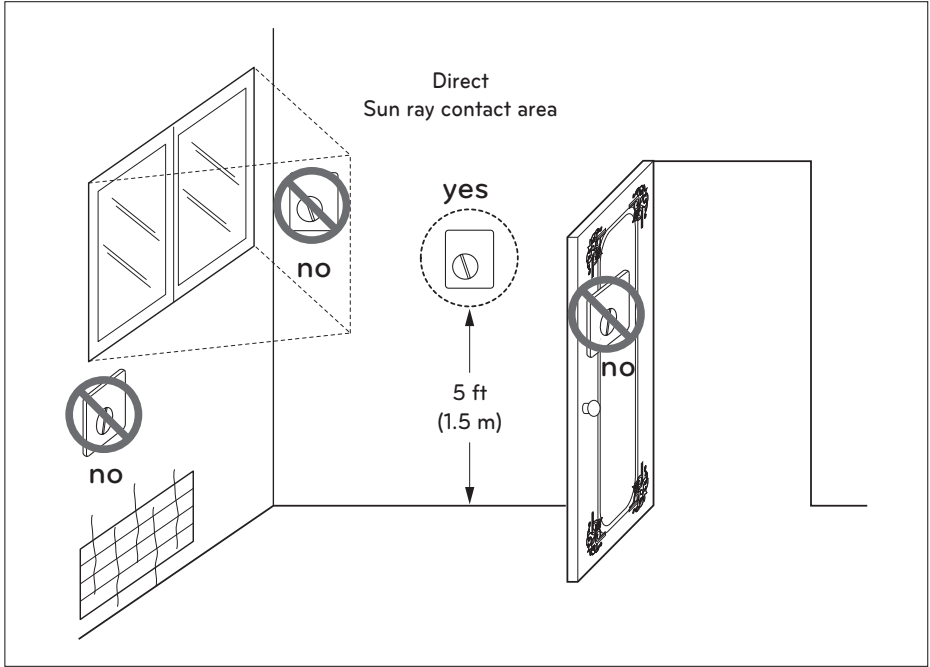

Thermostat

General Information

The Heat Pump supports following thermostats.

Type	Power	Operating Mode	Supported
Mechanical (1)	230 V~	Heating Only (3)	Yes
Electrical (2)	230 V~	Heating Only (3)	Yes

- (1) There is no electric circuit inside the thermostat and electric power supply to the thermostat is not required.
- (2) Electric circuit such as display, LED, buzzer, etc is included in the thermostat and electric power supply is required.
- (3) Thermostat generates "Heating ON or Heating OFF" signal according to user's heating target temperature.

How to wire thermostat

Follow below procedures Step 1 ~ Step 4.

Step 1. Uncover front cover of the unit and open the control box.

Step 2. Identify the power specification of the thermostat. If it is 220-240 V~, go to Step 3.

Step 3. If it is Heating only thermostat, go to step 4.

Step 4. Find terminal block and connect wire as below.

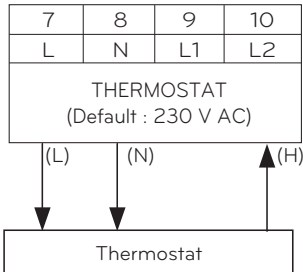

⚠ WARNING

Mechanical type thermostat.

Do not connect wire (N) as mechanical type thermostat does not require electric power supply.

⚠ CAUTION

Do not connect external electric loads.

Wire (L) and (N) should be used only for operation electric type thermostat.

Never connect external electric loads such as valves, fan coil units, etc. If connected, Main PCB (Heater) can be seriously damaged.

(L) : Live signal from PCB to thermostat

(N) : Neutral signal from PCB to thermostat

(H) : Heating signal from thermostat to PCB

Final check

- DIP switch setting :
Set DIP switch No. 8 to 'ON'. Otherwise, the unit can not recognize the thermostat.
- Remote Controller :
 - 'Thermostat' text is displayed on the remote controller.
 - Button input is prohibited.

3rd Party Controller

The product can also be linked to 3rd party controller. You can connect external controllers using Modbus protocol except for LG controller. If 3rd party controller is used, LG controller is not applied to AWHP simultaneously.

How to install 3rd party controller

Follow below procedures step 1 ~ step 4.

- Step 1.** Check if the power of the unit is turned off.
- Step 2.** Disassemble front panels and distinguish control box(Indoor) of the unit.
- Step 3.** Check if the harness(White) is inserted fully to the indoor unit PCB (CN_COM).
- Step 4.** Connect the 3rd party controller to terminal block 2(1/1/2) completely. (including Meter interface module)

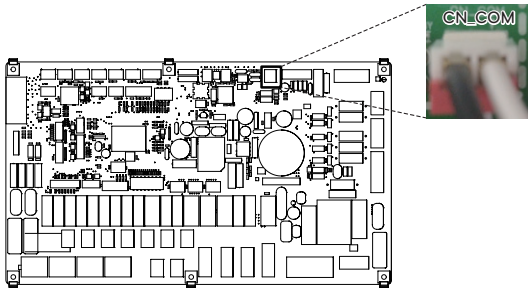
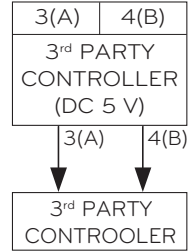

Indoor PCB

Central Controller

The product can communicate and control through the central controller. The following functions can be controlled in the central control linked state (Operation/Stop, Desired temperature, Hot water operation / stop, Warm water temperature, Full lock, Etc)

How to Installation PI485

Fix the PI485 PCB as shown in below images.

For detailed installation method refer to PI485 Installation Manual

Product Heating Capacity : 12 kW, 14 kW, 16 kW

U60A Chassis

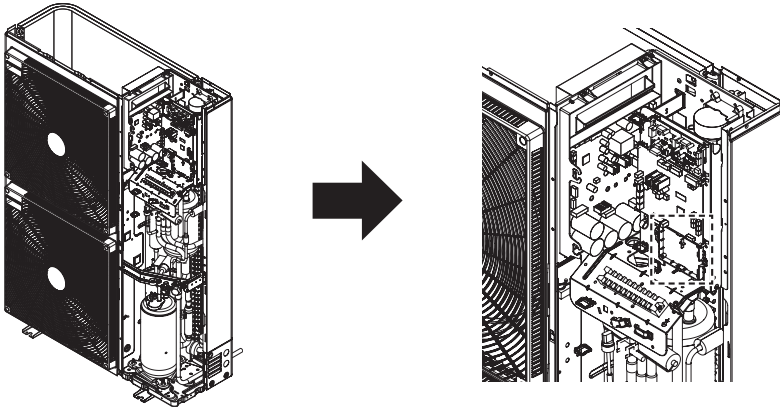

DHW Tank

To establish DHW circuit, 3way valve and DHW tank kit is required. If solar thermal system is pre-installed at the installation field, solar thermal kit is required to interface solar thermal system – to – DHW tank – to – **THERMAV.**

Installation condition

Installing sanitary water tank requires following considerations :

- Sanitary water tank should be located at the flat place.
- Water quality should be complied with EN 98/83 EC directives.
- As this water tank is sanitary water tank (indirect heat exchange), do not use anti water-freezing treatment like ethylene glycol.
- It is highly recommend to wash out inside of the sanitary water tank after installation. It ensures generating clean hot water.
- Near the sanitary water tank there should be water supply and water drain to easy access and maintenance.
- Set the maximum value of the temperature control device of sanitary tank.

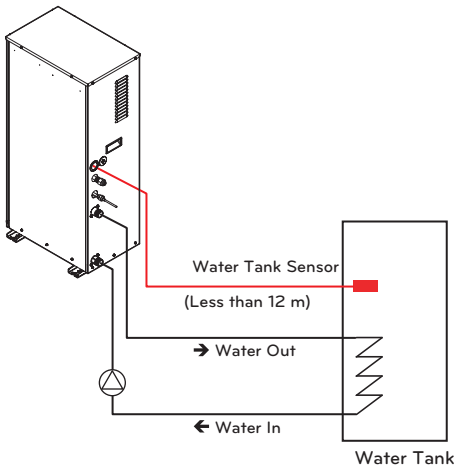

General Information

THERMAV. supports following 3way valve.

Type	Power	Operating Mode	Supported
SPDT 3-wire (1)	230 V AC	Selecting "Flow A" between "Flow A" and "Flow B" (2)	Yes
		Selecting "Flow B" between "Flow A" and "Flow B" (3)	Yes

(1) : SPDT = Single Pole Double Throw. Three wires consist of Live1 (for selecting Flow A), Live 2 (for selecting Flow B), and Neutral (for common).

(2) : 'Flow A' means water flow from the unit to under floor water circuit.

(3) : 'Flow B' means water flow from the unit to DHW tank.

Dry Contact

Dry Contact is a solution for automatic control of HVAC system at the owner's best. In simple words, it's a switch which can be used to turn the unit On/Off after getting the signal from external sources.

How to install dry contact

[Parts of Dry contact]

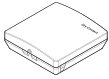

Dry Contact body



Cable(for connecting with IDU)

Follow below procedures step 1 ~ step 4.

Step 1. Check if the power of the unit is turned off.

Step 2. Disassemble front panels and distinguish terminal block in Indoor PCB.

Step 3. Connect cable to the unit PCB(CN_CC) fully.

Step 4. Then, Insert harness to the dry contact PCB(CN_INDOOR) firmly as shown below.

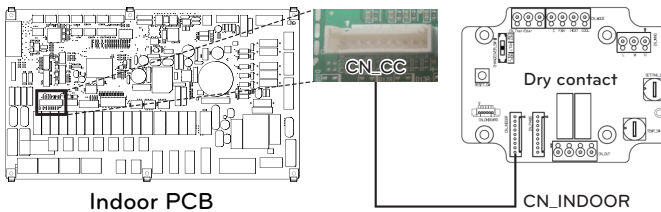

NOTE

- For more information about installing Dry Contact, Please refer installation manual provided with Dry Contact.
- For system set-up, please read chapter 8.(Especially function code No.6)

[Setting of Contact Signal Input]

- For input contact closure only (No power input)

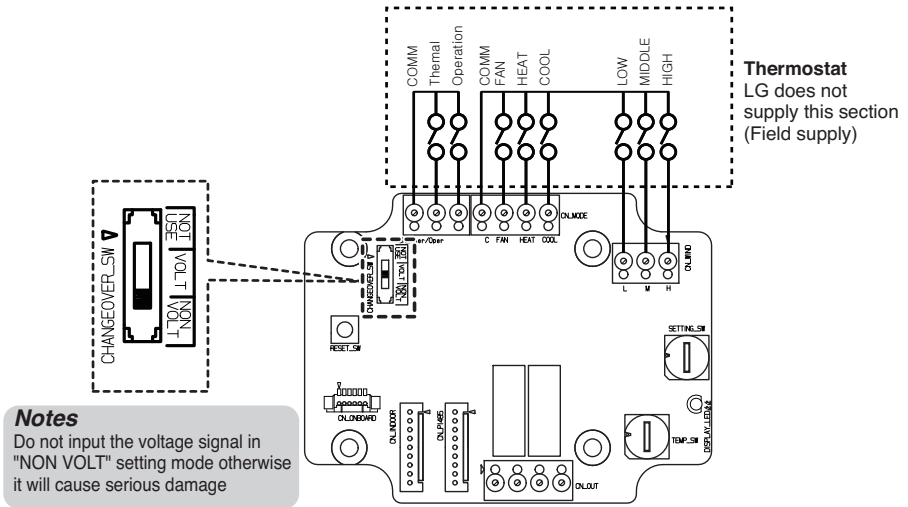

- For input contact voltage : DC 12 V, 24 V~

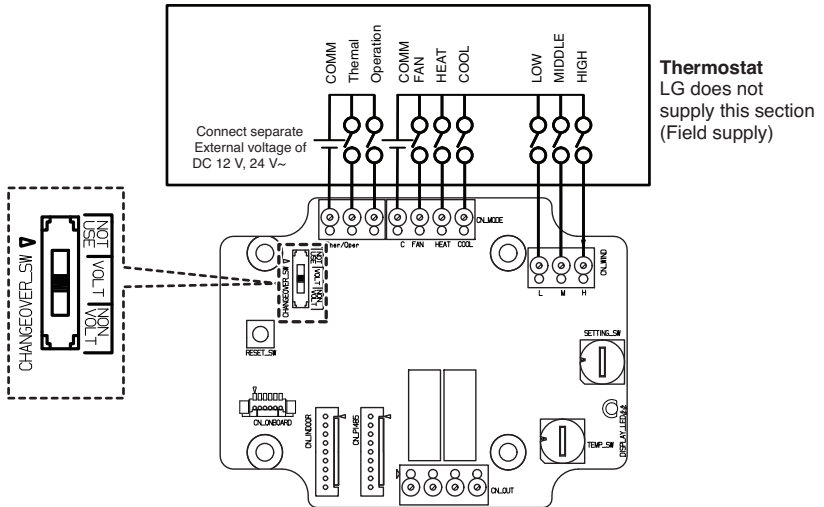

External Controller - Setting up programmable digital input operation

If you require to operate control depending on external digital input(ON/OFF), connect cable to indoor PCB(CN_EXT).

Follow below procedures step 1 ~ step 4.

Step 1. Check if the power of the unit is turned off.

Step 2. Disassemble front panels and distinguish control box(Indoor) of the unit

Step 3. Connect the external controller to PCB(CN_EXT) completely.

Step 4. Connect the cable and field installation part.

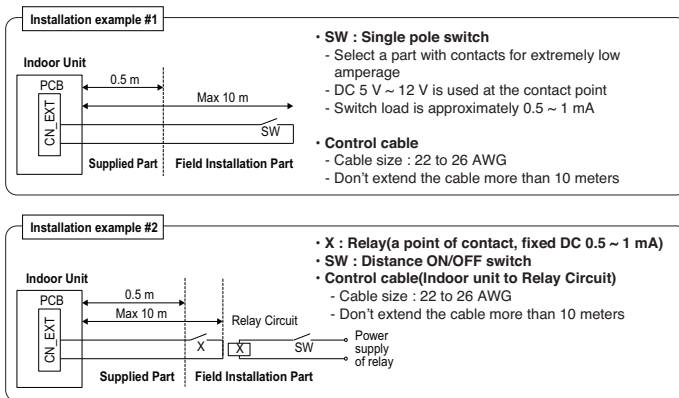
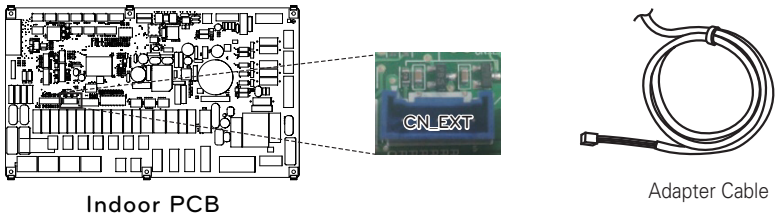

Determining the purpose of CN_EXT

Setting value: 0 ~ 5 step Indoor CN-EXT port setting

- 0: default

- 1: Simple operation on / off

- 2: Dry contact (simple contact)

- 3: Emergency stop only for indoor unit

- 4: Reattachment / absence

- 5: Emergency stop of all indoor units (It can be set only when indoor unit has emergency stop function)

Remote Temperature Sensor

Remote temperature sensor can be installed any place a user wants to detect the temperature.

- The function is not available for some products.

Installation condition

Role and constraint while installation of remote air temperature sensor is very similar to that of thermostat.

- Distance between the unit and the remote air temperature sensor should be less than 15 m due to length of the connection cable of remote air temperature sensor.
- For other constraints, please refer to previous page where constraints about thermostat is described.

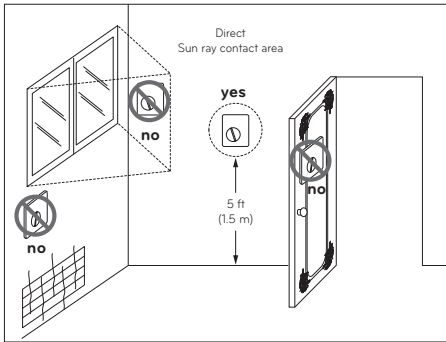

Thermostat

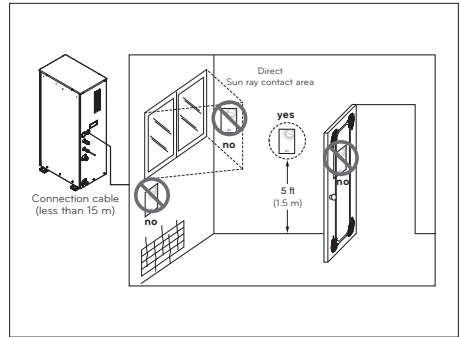

Remote Air Temperature Sensor

How to Install Remote Temperature Sensor

[Parts of Remote Temperature Sensor]



Sensor



Screw(to fix remote sensor)

Follow below procedures step 1 ~ step 5.

- Step 1.** Decide where the remote temperature sensor is installed. Then, Determine the location and height of the fixing screws in fig. 1 (Interval between the screws : 60 mm)
- Step 2.** Check if the power of the unit is turned off.
- Step 3.** Disassemble front panels and distinguish control box(Indoor) of the unit.
- Step 4.** Insert temperature sensor into PCB(CN_ROOM) and fix the sensor firmly in fig. 2.
- Step 5.** The Connection wire does not matter if you change the color of the wire because of nonpolar.

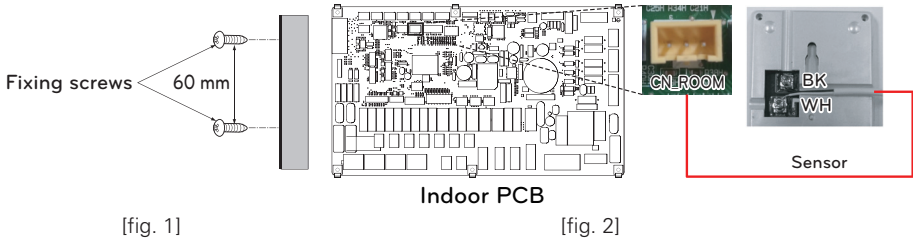

Step 6. Integrate the remote temperature sensor with the screws as the order of arrows.

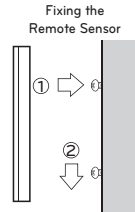

⚠ CAUTION

- Choose the place where the average temperature can be measured for the unit operates.
- Avoid direct sunlight.
- Choose the place where the cooling/heating devices do not affect the remote sensor.
- Choose the place where the outlet of the cooling fan do not affect the remote sensor.
- Choose the place where the remote sensor isn't affected when door is open.

NOTE

- For more information about installing Remote Temperature Sensor, Please refer installation manual provided with Remote Temperature Sensor.
- For system set-up, please read chapter 8.(Especially function code No.3)

External pump

External pump can be required when the room to take floor heating is too large or not well-insulated.(potential free)

How to install external pump

Follow below procedures step 1 ~ step 3.

Step 1. Check if the power of the unit is turned off.

Step 2. Disassemble front panels and distinguish terminal block in Indoor PCB.

Step 3. Connect signal cable to terminal block (TB_EXT_PUMP) fully.

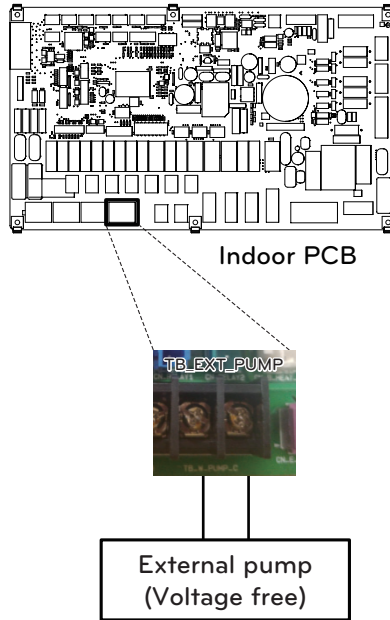

Wi-fi Modem

Wi-fi modem enables remote system operation from smartphone. Available functions include selection of on/off, operation mode, DHW heating, temperature setup and weekly scheduling etc.

How to install Wi-fi Modem

[Parts of Wi-fi modem]



Wi-fi modem body

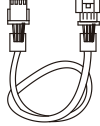

USB Cable

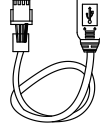

Extension Cable

Follow below procedures step 1 ~ step 5.

Step 1. Check if the power of the unit is turned off.

Step 2. Disassemble front panels and distinguish control box(Indoor) of the unit.

Step 3. Connect the USB cable to the indoor unit PCB (CN_WF ; Blue) until it clicks into place.

Step 4. Connect the Wi-Fi modem to the USB cable fully.

Step 5. Refer to the image below to install the Wi-Fi modem in the marked position.

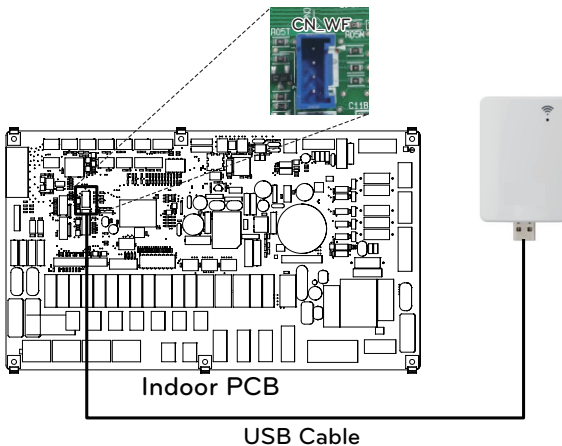

Smart Grid

This product provides SG Ready function for users. It enables to stop internal operation(Heating / DHW) and control target temperature depending on input signal from power provider.

How to install smart grid

Follow below procedures step 1 ~ step 3.

Step 1. Check if the power of the unit is turned off.

Step 2. Disassemble front panels and distinguish terminal block in Indoor PCB.

Step 3. Connect signal cable to terminal block in PCB (TB_SG2, TB_SG1) fully as shown below.

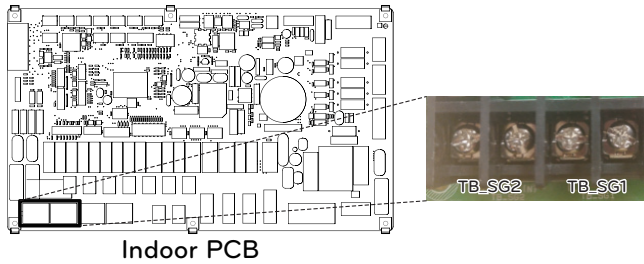

Heating and DHW Operation depend on input signal(SG1 / SG2)

Status display	Input Signal		Command	Cost (Electric)	Operation	
	SG1	SG2			Heating	Domestic How Water
SGN	Open	Open	Normal Operation	Normal Price	Maintain operation status	Maintain operation status
SG1	Close	Open	Operation Off (Utility lock)	High Price	Forced internal operation off	Forced internal operation off
SG2	Open	Close	Operation On Recommend	Low Price	Target temperature change automatically depend on SG Mode value in installer setting - Step 0 : maintain target temperature - Step 1 : increase 2 °C from target temperature - Step 2 : increase 5 °C from target temperature	Target temperature change automatically depend on SG Mode value in install setting - Step 0 : increase 5 °C from target temperature - Step 1 : increase 5 °C from target temperature - Step 2 : increase 7 °C from target temperature
SG3	Close	Close	Operation On Command	Very Low Price	Maintain operation status	Target temperature change automatically to 80 °C

3Way Valve(A)

3Way Valve(A) is required to operate DHW water tank. Role of 3way valve is flow switching between under floor heating loop and water tank heating loop. Plus, it is required to operate 3rd party boiler.

General Information

THERMAV supports following 3way valve.

Type	Power	Operating Mode	Supported
SPDT 3-wire (1)	220-240 V~	Selecting "Flow A" between "Flow A" and "Flow B" (2)	Yes
		Selecting "Flow B" between "Flow A" and "Flow B" (3)	Yes

(1) : SPDT = Single Pole Double Throw. Three wires consist of Live1 (for selecting Flow A), Live 2 (for selecting Flow B), and Neutral (for common).

(2) : Flow A means 'water flow from the unit to under floor water circuit.'

(3) : Flow B means 'water flow from the unit to DHW water tank.'

How to wire 3way valve(A)

Follow below procedures Step 1 ~ Step 2.

Step 1. Uncover front cover of the unit.

Step 2. Find terminal block and connect wire as below.

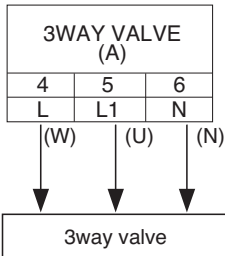

WARNING

- 3way valve should select water tank loop when electric power is supplied to wire (W) and wire (N).
- 3way valve should select under floor loop when electric power is supplied to wire (U) and wire (N).

(W) : Live signal (Water tank heating) from PCB to 3way valve

(U) : Live signal (Under floor heating) from PCB to 3way valve

(N) : Neutral signal from PCB to 3way valve

Wired Remote Controller

This is the accessory kit to install two remote controllers on unit with 2-remo cable. One remote controller will show all settings including installer settings, the other will show only owner settings.

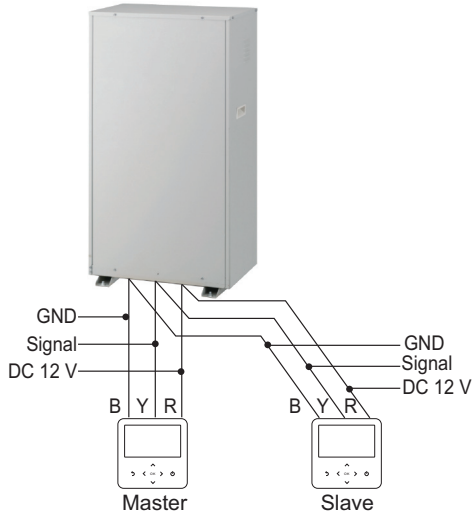

Use the function "Installer setting - RMC master/slave". After completing the RMC master/slave setting, turn off the power of indoor unit. And then, turn on the power again after 1 minute.

[Components]



2-Remo Cable



Extension cable



Screw (4 EA)



Remote controller
(Front/back case)

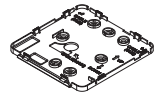

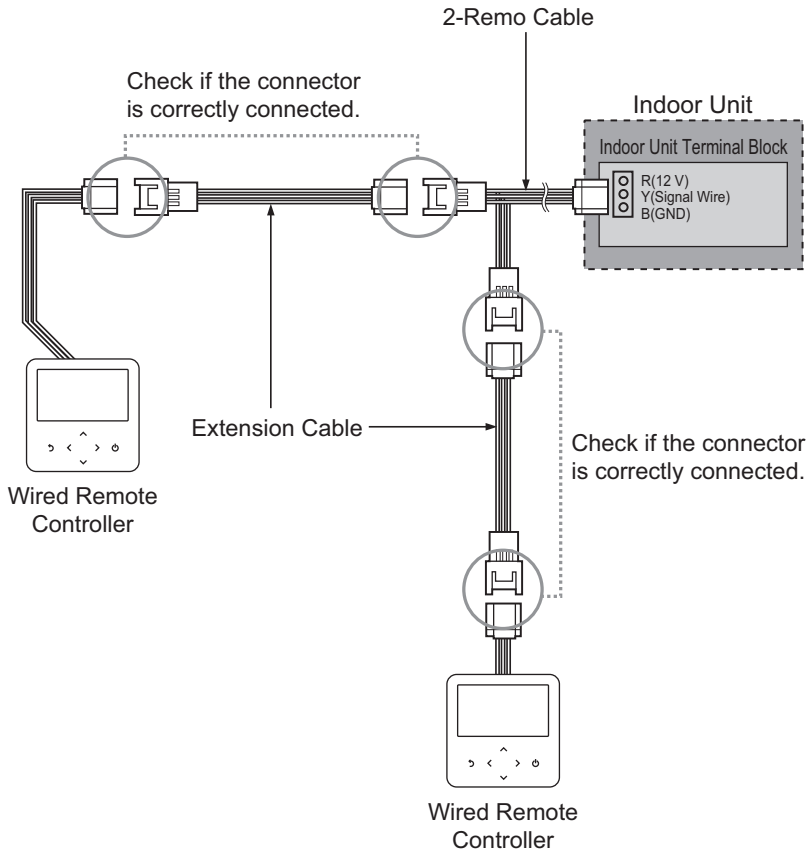
[Wiring diagram]

CONFIGURATION

As **THERMAX** is designed to satisfy various installation environment, it is important to set up system correctly. If not configured correctly, improper operation or degrade of performance can be expected.

DIP Switch Setting

! CAUTION

Turn off electric power supply before setting DIP switch

- Whenever adjusting DIP switch, turn off electric power supply to avoid electric shock.





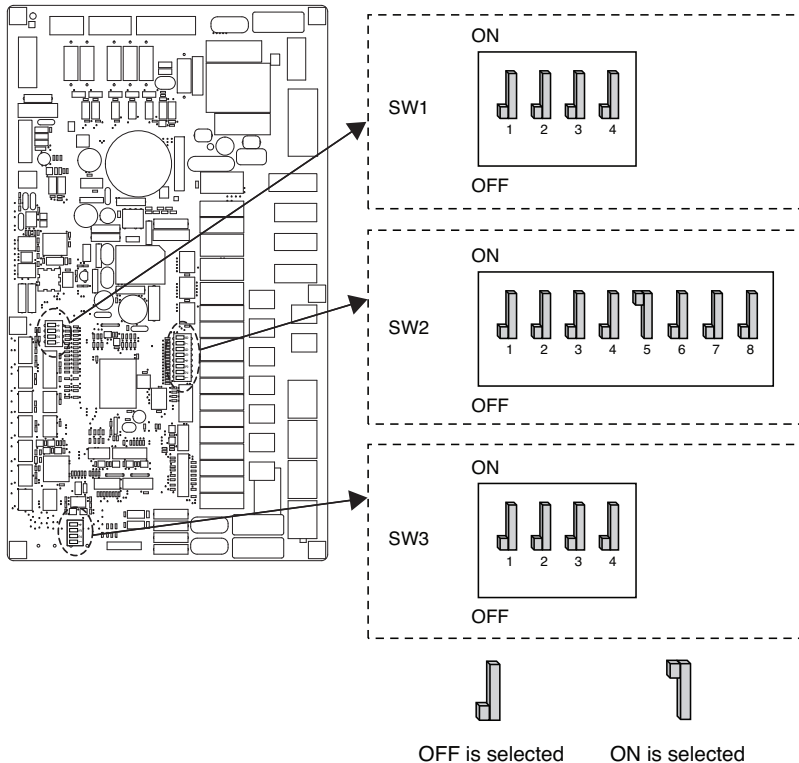

















General Information

Indoor PCB



DIP Switch Information

Option Switch 2













Description	Setting	Default
Role when central controller is equipped	1  As Master	1 
	1  As Slave	
Accessory installation information	  Unit + Outdoor unit is installed	2  3 
	  Unit + Outdoor unit + DHW tank is installed	
	  DHW tank Only	
Cycle	4  Heating Only	4 
Flow Switch (Flow Sensor) Detection	5  Always	5 
	5  While water pump is on	
Selecting electric heater capacity	  Electric heater is not used	6  7 
Thermostat installation information	8  Thermostat is NOT installed	8 
	8  Thermostat is installed	













CAUTION

- When an external pump or other boiler is installed Dip switch No.5 setting change (Off → On) need to be added

Option Switch 1

Description	Setting		Default
MODBUS	1 	As Master	1 
	1 	As Slave	
MODBUS Function	2 	Common 3 rd party	2 
	2 	SIEMENS	
Reserved	 3	 3	3 
Reserved	 4	 4	4 

Option Switch 3

Description	Setting		Default
Remote Air Sensor	1 	Remote sensor is not installed	1 
	1 	Remote sensor is installed	
ANTIFREEZE	2 	Antifreeze mode not use	2 
Reserved	 3	 3	3 
Reserved	 4	 4	4 

DIP Switch Information

Indoor Cycle PCB

※ All pins are reserved (Don't select)

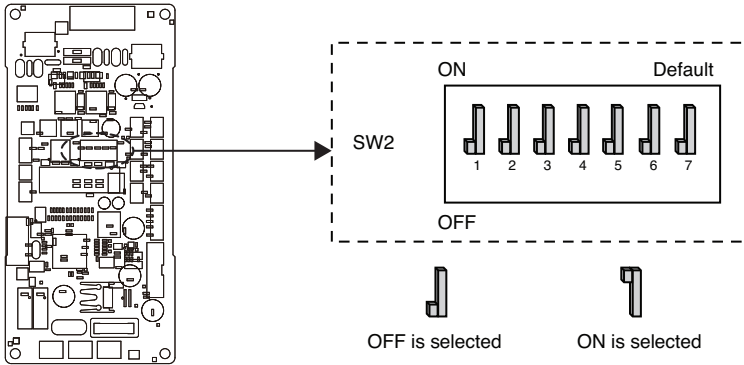

Outdoor Cycle PCB

※ All pins are reserved (Don't select)

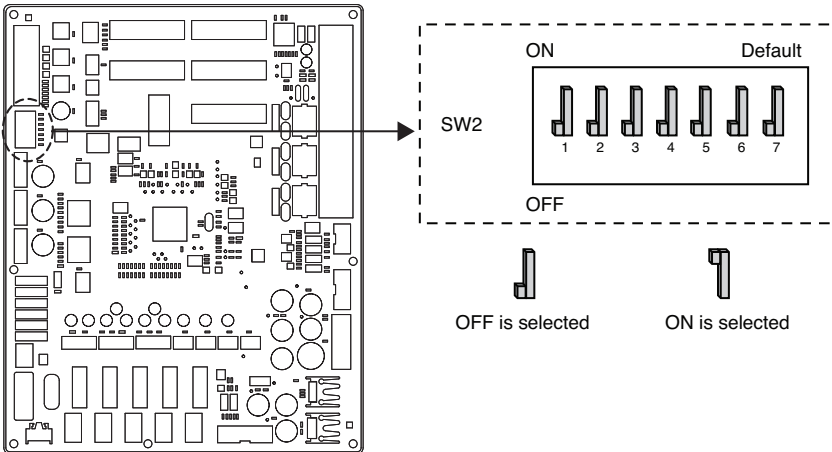

NOTE**Emergency Operation****• Definition of terms**

- Trouble : a problem which can stop system operation, and can be resumed temporarily under limited operation without certificated professional's assist.
- Error : problem which can stop system operation, and can be resumed ONLY after certificated professional's check.
- Emergency mode : temporary heating operation while system met Trouble.

• Objective of introducing 'Trouble'

- Not like airconditioning product, Air-to-Water heat pump is generally operation in whole winter season without any system stopping.
- If system found some problem, which is not critical to system operating for yielding heating energy, the system can temporarily continue in emergency mode operation with end user's decision.

• Classified Trouble

- Trouble is classified two levels according to the seriousness of the problem : Slight Trouble and Heavy trouble
- Slight Trouble : a problem is found inside the unit. In most case, this trouble is concerned with sensor problems.
- Heavy trouble : a problem is found inside the outdoor unit . In most case, this trouble is concerned with Compressor cycle trouble.
- Option Trouble : a problem is found for option operation such as water tank heating. In this trouble, the troubled option is assumed as if it is not installed at the system.

• When the AWHP has any trouble,

- (1) If there is not a function to judge possibility of operation :

Once an error occurs mainly in indoor unit, AWHP stops. On the other hand, Remocon allows the product to activate On/ Off operation. (On : emergency operation)

- Slight / Heavy trouble : Heating Operable only
- Critical trouble : Full stop
- Treatment priority : Critical>Heavy>Slight

- (2) If there is a function to judge possibility of operation :

Depending on the status of slight / heavy / critical trouble, pop-up phrase is guided separately on display.

- Slight trouble : Heating Operable
- Heavy trouble : Heating Operable only
- Critical trouble : Service center request

AWHP operates when user pressed OK button on pop-up window.

NOTE**• Duplicated trouble : Option trouble with slight or heavy trouble**

- If option trouble is occurred with slight (or heavy) trouble at the same time, the system puts higher priority to slight (or heavy) trouble and operates as if slight (or heavy) trouble is occurred.
- Therefore, sometimes DHW heating can be impossible in emergency operation mode. When DHW is not warming up while emergency operation, please check if DHW sensor and related wiring are all Ok.

• Emergency operation is not automatically restarted after main electricity power is reset.

- In normal condition, the product operating information is restored and automatically restarted after main electricity power is reset.
- But in emergency operation, automatic re-start is prohibited to protect the product.
- Therefore, user must restart the product after power reset when emergency operation has been running.

SERVICE SETTING

How to enter service setting

To enter the menu displayed at the bottom, you need to enter the service setting menu as follows.

- In the menu screen, press [←,→(left/right)] button to select the setting category, and press [OK] button to move to the setting list.
- In the setting list, select the service setting category, and press [OK] button to move to the service setting list.

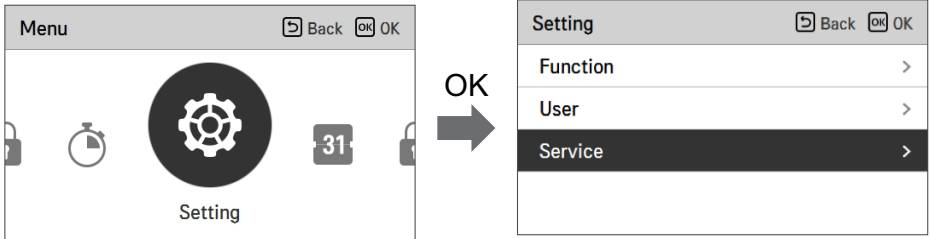

Service setting

- You can set the product service functions.
- Some functions may not be displayed/operated in some product types.

Menu	Description
Service contact	Check and input the service center phone number that you can call when there is service issue.
Model information	View product and capacity information
RMC Version Information	Check the remote controller model name and software version.
Open Source License	View the remote controller's open source license.

Service contact

Check and input the service center phone number that you can call when there is service issue.

- In the service setting list, select the service contact point and press [OK] button to move to the detail screen.
- While “edit” button is selected, press [OK] button to move to the edit screen, change it, and press [OK] button to change the service contact point.

Service		Back	OK
Service Contact			>
Model Information			>
RMC Version Information			>
Open Source License			>



Service Contact		Back	OK
Telephone			
+1544-7777			
Edit			



Service Contact		Back	OK				
Telephone							
+	1	5	4	4	-	7	7
7	7						

Model information

Check product and capacity information to which the remote controller is connected.

- In the service setting list, select model information category, and press [OK] button to move to the detail screen.
- The unit capacity
 - $1 \text{ kWh} = 1 \text{ kBtu} * 0.29307$
 - kWh is the result calculated based on Btu, There may be a small difference between calculated and actual capacity.
 - Ex) If the unit capacity is 18 kBtu, it is displayed as 5 kWh.

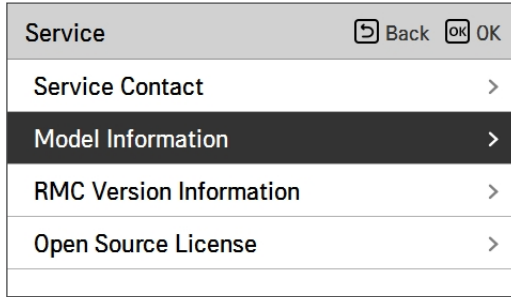

OK

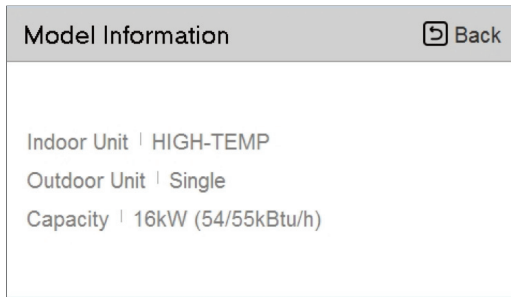

RMC version Information

View the remote controller software version.

- In the service setting list, select the RMC version information and press [OK] button to move to the detail screen

Service	Back	OK
Service Contact	>	
Model Information	>	
RMC Version Information	>	
Open Source License	>	



RMC Version Information	Back
SW Version 3.03.1a	

Open source license

View the remote controller's open source license.

- In the service setting list, select the open source license category, and press [OK] button to move to the detail screen.

Service	Back	OK
Service Contact	>	
Model Information	>	
RMC Version Information	>	
Open Source License	>	



Open Source License		Back
LGE Open Source Software Notice		
Product Type	HVAC WIRED REMOTE CONTR	
Model Number/Range	RS3 Wired Remote Controller	1/401
Those products identified by the Product Type and Model Range above from LG Electronics, Inc. ("LGE") contain the open source software detailed below. Please refer to the		

INSTALLER SETTING

How to enter installer setting

⚠ CAUTION

The installer setting mode is the mode to set the remote controller's detail function. If the installer setting mode is incorrectly set, it may cause product failure, user's injury, or property damage. It must be set by the installation specialist with the installation license, and if it is installed or changed without installation license, all problems caused will be the responsibility of the installer, and may void the LG warranty.

- In the menu screen, press [←,→(left/right)] button to select the setting category, and press [^ (up)] button for 3 seconds to enter the password input screen for the installer setting.
- Input the password and press [OK] button to move to the installer setting list.

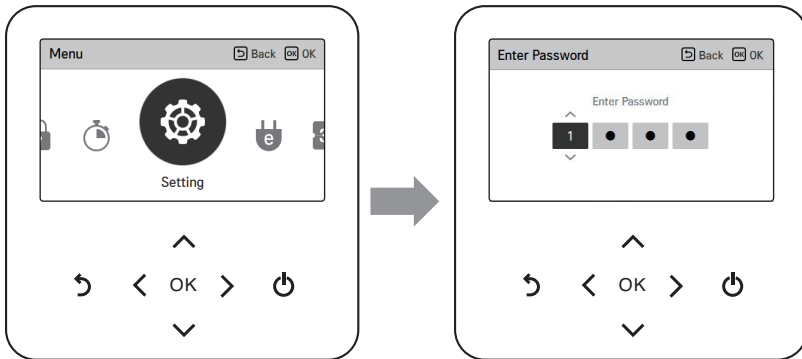

※ Installer setting password

Main screen → menu → setting → service → RMC version information → SW Version

Example) SW version : 1.00.1 a

In the above case, the password is 1001.

NOTE

Some categories of the installer setting menu may not be available depending on the product function or the menu name may be different.

Installer setting

- You can set the product user functions.
- Some functions may not be displayed/operated in some product types.

Function	Description
3 Minutes Delay	Factory use only
Select Temperature Sensor	Selection for setting temperature as air temperature or leaving water temperature or air+leaving water temperature
Dry Contact Mode setting	Dry contact function is the function that can be used only when the dry contact devices is separately purchased and installed.
Central Control address	When connecting the central control, set the central control address of the unit.
Pump Test run	Water pump test run
Air heating set temp. setting	Adjusting range of 'Setting Air Temperature' in heating mode
Water heating set temp. setting	Adjusting range of 'Setting Heating Flow Temperature' in heating mode
DHW Set Temp.setting	Setting DHW set temperature
Outdoor temp. for auto mode	Setting Outdoor Min/Max temperature for auto mode
Indoor air temp. for auto mode	Setting indoor Min/Max temperature for auto mode
LWT temp. for auto mode	Setting leaving water Min/Max temperature for auto mode
Tank disinfection setting 1	Setting start/maintain time for pasteurisation
Tank disinfection setting 2	Setting pasteurisation temperature
Tank setting 1	Setting start temperature for operation
Tank setting 2	Setting maintain temperature for operation
DHW time setting	Determine follow time duration : operation time of domestic hot water tank heating, stop time of domestic hot water tank heating, and delay time of DHW tank heater operating
TH on/off Variable, heating air setting	Heating air temperature TH On / Off Type setting
TH on/off Variable, heating Water setting	Heating Water Outlet Temperature TH On / Off Type

Function	Description
Heating temp. setting	At the leaving water control in heating mode, the control reference water temperature position setting
Pump setting in heating	Set water pump on / off delay option in heating mode
Forced operation	Water pump off After 20 consecutive hours, disable / enable the logic that drives the water pump by itself
CN_CC setting	It is the function to set whether to install (use) Dry Contact. (It is not a function for Dry Contact installation, but it is a function to set the usage of the unit's CN_CC port.)
Smart Grid(SG) setting	Select whether to use or not use the SG Mode function of the product, set the operation option value in SG1 step.
IDU Address Verification	Function to check the result of Auto Addressing of outdoor unit with remote control.
CN_EXT	Function to set external input and output control according to DI / DO set by customer using dry contact port of indoor unit. Determine the use of the contact port (CN_EXT) mounted on the indoor unit PCB
Use External Pump	Set up to control an external water pump
Pump Prerun/Overrun	Set to reach the optimum flow rate by circulating the heating water with the water pump before heat exchange. After the operation stop, additional water pump is activated to circulate the heating water.
Data logging setting	Display error history of connected unit
Password Initialization setting	It is the function to initialize (0000) the password when you forgot the password set in the remote controller.

3 Minutes Delay

Temporarily eliminates the 3-minute delay function of the outdoor unit Comp

- Factory use only

- In the installer setting list, select 3 Minutes Delay category, and press [OK] button to move to the detail screen.

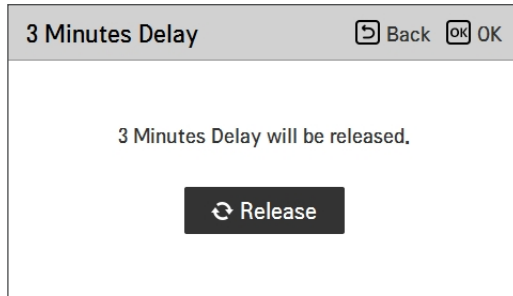
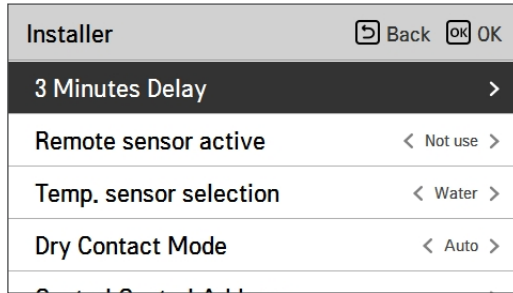

Select Temperature Sensor

The product can be operated according to air temperature or leaving water temperature. The selection for setting temperature as air temperature or leaving water temperature is determined.

- In the installer setting list, Select Temperature Sensor category, and press [OK] button to move to the detail screen.

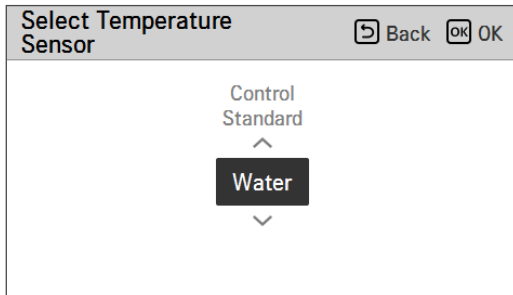
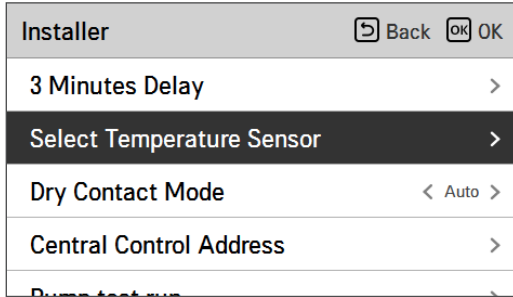

Value		
Water	Air	Water + Air

NOTE

Air temperature as setting temperature is ONLY available when Remote Air Sensor Connection is enabled and Remote Air Sensor Connection is set as 02.

Dry Contact Mode

Dry contact function is the function that can be used only when the dry contact devices is separately purchased and installed.

- Change setting values using [<,>(left/right)] button.

Installer		Back	OK
3 Minutes Delay	>		
Remote sensor active	< Not use >		
Temp. sensor selection	< Water >		
Dry Contact Mode	< Auto >		

Value
Auto
manual

NOTE

For dry contact mode related detail functions, refer to the individual dry contact manual.

What is dry contact?

It means the contact point signal input when the hotel card key, human body detection sensor, etc. are interfacing with the air conditioner.

Added system functionality by using external inputs (dry contacts and wet contacts).

Central Control Address

When connecting the central control, set the central control address of the unit.

- In the installer setting list, select Central Control Address category, and press [OK] button to move to the detail screen.

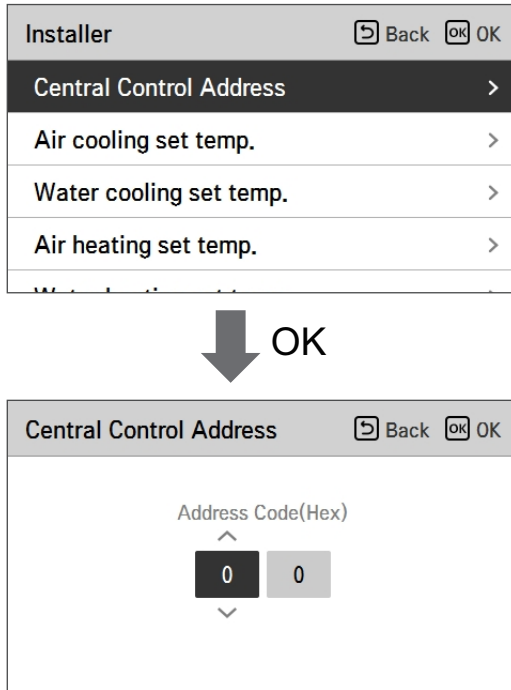

NOTE

Enter address code as hexadecimal value
 Front: Central Control Gr. No.
 Back side: Central control indoor the number

Pump test run

The pump test run is the function to test run by operating the water pump. This function can be used for air vents / flow sensors and others.

- In the installer setting list, Pump Test run category, and press [OK] button to move to the detail screen.

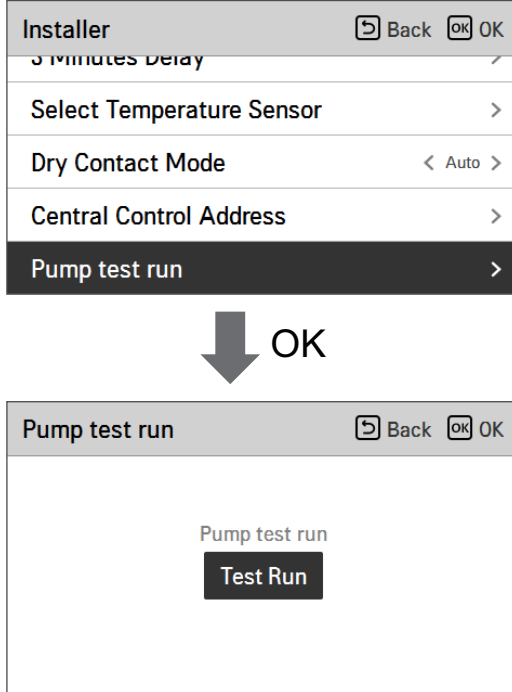

Air heating set temp.

Determine heating setting temperature range when air temperature is selected as setting temperature

- In the installer setting list, select Air heating set temp. category, and press [OK] button to move to the detail screen.

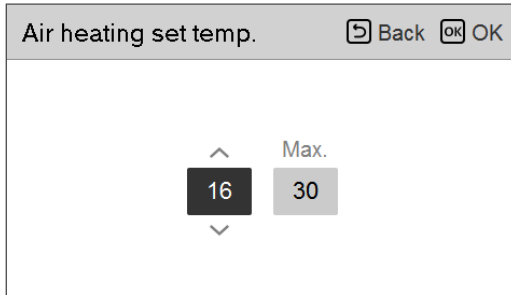
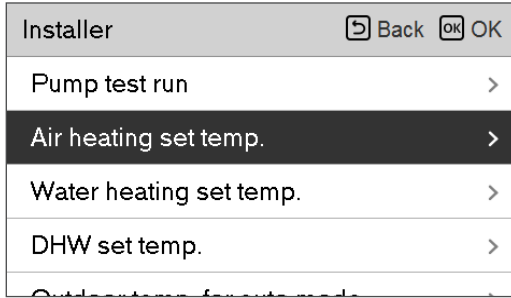

Value	Default	Range
Max.	30	30~24
Min.	16	22~16

* Upper / lower limit / default value is in °C

CAUTION

Only available when remote air temperature sensor is connected.

- Accessory PQRSTA0 should be installed.
- Also, Remote air sensor connection should be set properly.

Water heating set temp

Determine heating setting temperature range when leaving water temperature is selected as setting temperature.

- In the installer setting list, select Water heating set temp. category, and press [OK] button to move to the detail screen.

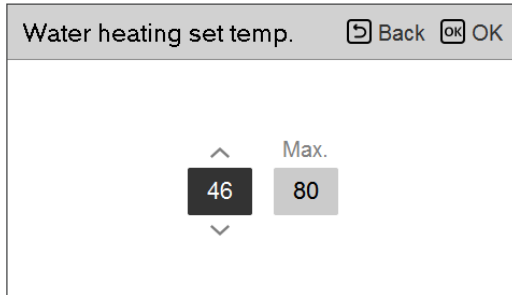
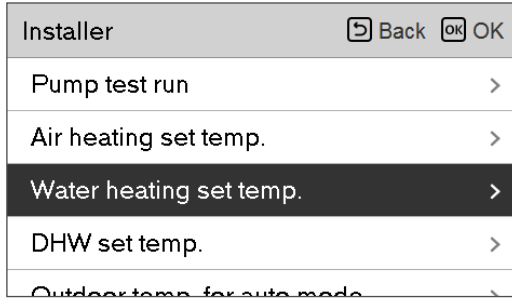

Value	Default	Range
Max.	80	50~80
Min.	46	30~46

* Upper / lower limit / default value is in °C.

DHW set temp

Determine heating setting temperature range when DHW temperature is selected as setting temperature

- In the installer setting list, select DHW set temp. category, and press [OK] button to move to the detail screen.

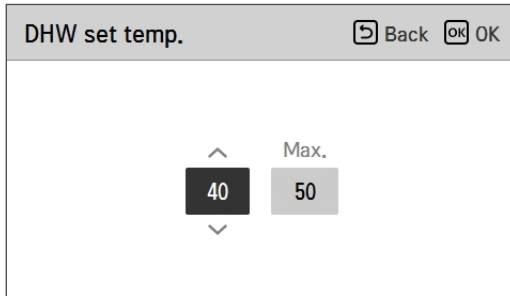
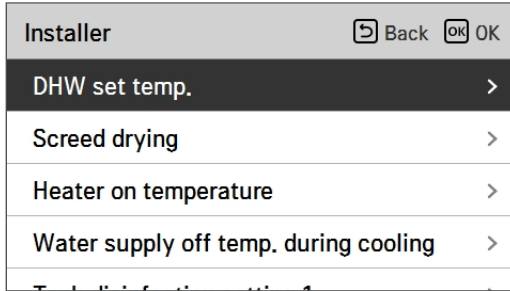

Value	Range
Max.	80~50
Min.	40~30

* Upper / lower limit / default value is in °C

Outdoor temp. for auto mode

It is the function to set the outdoor Min/Max temperature for auto mode.

- In the installer setting list, select Outdoor temp. for auto mode category, and press [OK] button to move to the detail screen.

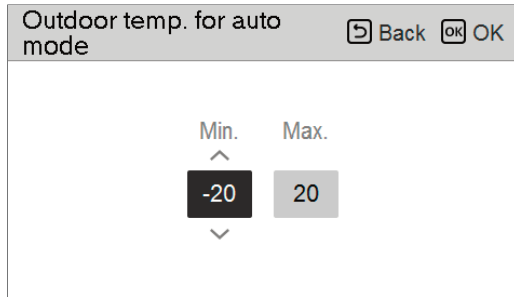
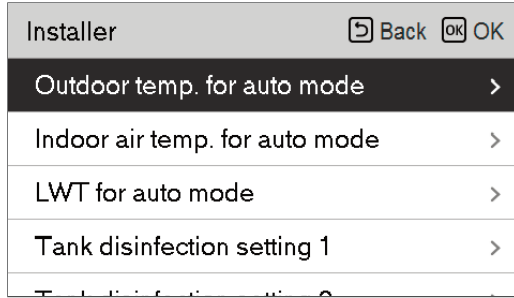

Value	Default	Range
Max.	15	20 ~ 10
Min.	-10	5 ~ -20

* Upper / lower limit / default value is in °C

NOTE

Auto mode is that the unit automatically adjusts target temperature (indoor air or Leaving water) according to the outdoor air temperature.

Indoor air temp. for auto mode

It is the function to set the indoor Min/Max temperature for auto mode.

- In the installer setting list, select indoor air temp. for auto mode category, and press [OK] button to move to the detail screen.

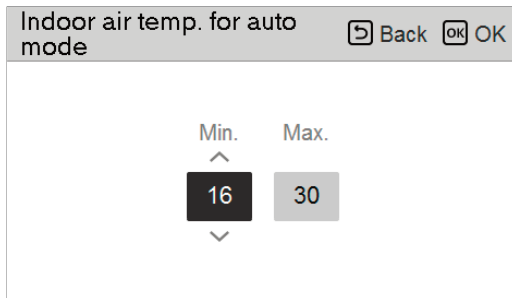
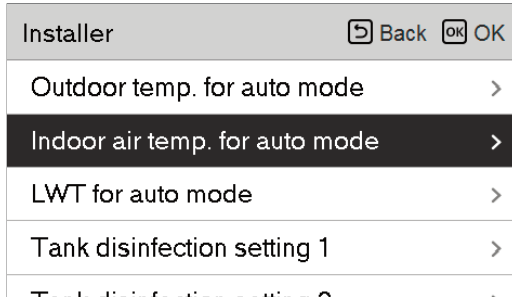

Value	Default	Range
Max.	21	30 ~ 20
Min.	16	19 ~ 16

* Upper / lower limit / default value is in °C

NOTE

Auto mode is that the unit automatically adjusts target temperature (indoor air or Leaving water) according to the outdoor air temperature.

LWT temp. for auto mode

It is the function to set the leaving water Min/Max temperature for auto mode.

- In the installer setting list, select Outdoor temp. for auto mode category, and press [OK] button to move to the detail screen.

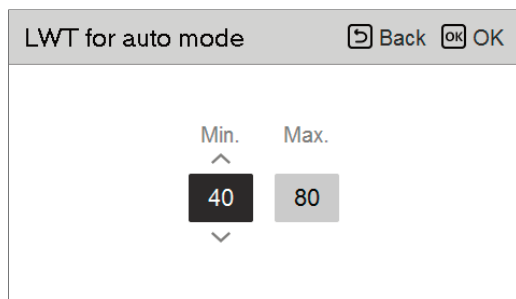
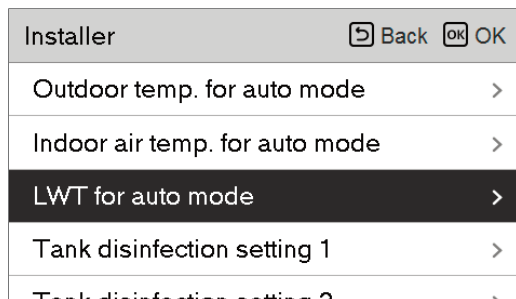

Value	Default	Range
Max.	80	80 ~ 65
Min.	50	54 ~ 40

* Upper / lower limit / default value is in °C

NOTE

Auto mode is that the unit automatically adjusts target temperature (indoor air or Leaving water) according to the outdoor air temperature.

Tank disinfection setting 1, 2

- Disinfection operation is special DHW tank operation mode to kill and to prevent growth of viruses inside the tank.
 - Disinfection active : Selecting enable or disable of disinfection operation.
 - Start date : Determining the date when the disinfection mode is running.
 - Start time : Determining the time when the disinfection mode is running.
 - Max temp. : Target temperature of disinfection mode.
 - Duration time : Duration of disinfection mode.

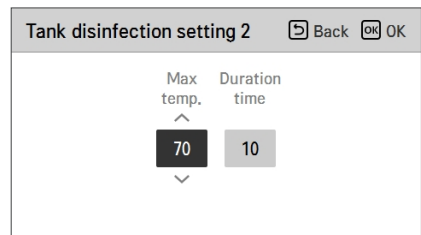
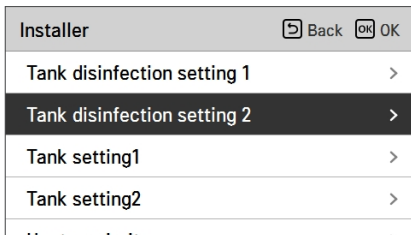
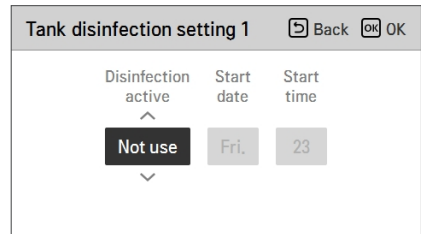
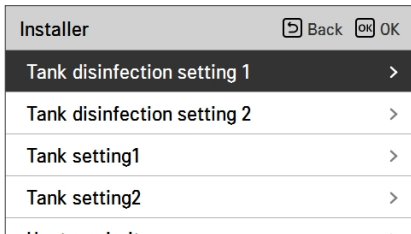
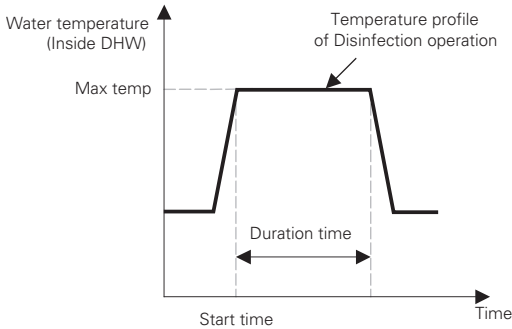

NOTE

DHW heating should be enable

- If Disinfection active is set as ' Not use', that is 'disable disinfection mode', Start date and Start time is not used.

Tank setting 1

- In the installer setting list, select tank setting 1 category, and press [OK] button to move to the detail screen.

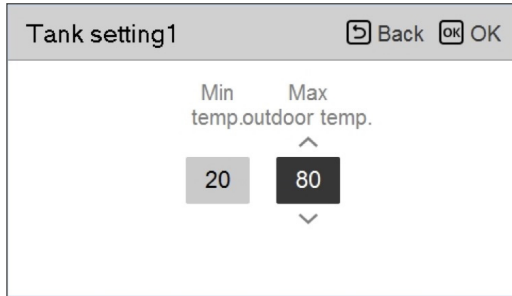
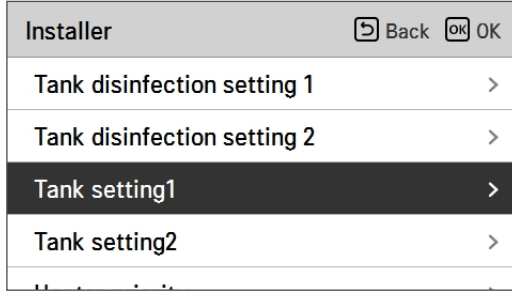

Value	Range
Max outdoor temp	80~40
Min temp	20~1

Tank setting 2

- In the installer setting list, select tank setting 2 category, and press [OK] button to move to the detail screen.

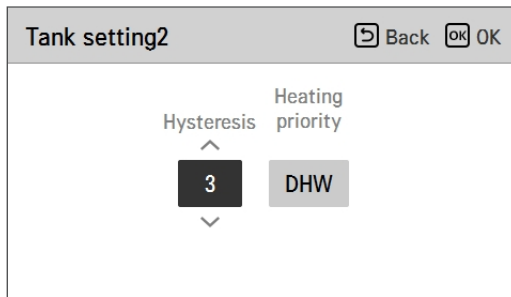
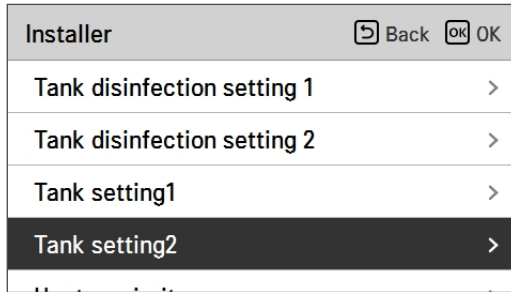

Value	Range
Hysteresis	4~2
Heating priority	Floor heating / DHW

• Tank setting 1, 2

Descriptions for each parameters are as following.

- Min temp. : temperature gap from Max outdoor temp.
- Max outdoor temp. : maximum temperature generated by AWHP compressor cycle.
- Example : If Min temp. is set as '5' and Max outdoor temp. is set as '48', then Water tank heating will be started when the water tank temperature is below 43 °C.

- Hysteresis : temperature gap from target DHW temperature.
- Heating priority : Determining heating demand priority between DHW tank heating and under floor heating.
- Example : If user's target temperature is set as '70' and Hysteresis is set as '3', then the water tank heating will be turned off when the water temperature is above 73 °C. The water tank heating will be turned on when the water temperature is below 70 °C.
- Example : If Heating priority is set as 'DHW', that means heating priority is on DHW heating, DHW is heated by AWHP compressor cycle. In this case the under floor can not be heated while DHW heating. On the other hand, if the Heating priority is set as 'Floor heating', that means heating priority is on under floor heating, DHW tank can not be heated While under floor heating.

NOTE

DHW heating does not operate when it is disabled.

DHW time setting

Determine following time duration : operation time of DHW tank heating, stop time of DHW tank heating, and delay time of DHW tank heater operating.

- Active time : This time duration defines how long time DHW tank heating can be continued.
- Stop time : This time duration defines how long time DHW tank heating can be stopped. It is also regarded as time gap between DHW tank heating cycle.

TH on/off Variable, heating air

It is a function to adjust the heating air temperature Thermal On / Off temperature according to the field environment in preparation for heating or heating claim.

- You can set the following setting values using [<,>(left/right)] button.

Installer	Back	OK
Heater priority	>	
DHW time setting	>	
TH on/off Variable, heating air	< Type0 >	
TH on/off Variable, heating water	< Type0 >	

Value	Description	
	TH On	TH Off
Type0	-0.5 °C	1.5 °C
Type1	-1 °C	2 °C
Type2	-2 °C	3 °C
Type3	-3 °C	4 °C

TH on/off Variable, heating water

It is a function to adjust the heating water temperature Thermal On / Off temperature according to the field environment in preparation for heating or heating claim.

- You can set the following setting values using [<, >(left/right)] button.

Installer		Back	OK
Heater priority	>		
DHW time setting	>		
TH on/off Variable, heating air	< Type0 >		
TH on/off Variable, heating water	< Type0 >		

Value	Description	
	TH On	TH Off
Type0	-2 °C	2 °C
Type1	-3 °C	3 °C
Type2	-4 °C	4 °C
Type3	-1 °C	1 °C

Heating temp. setting

- At the leaving water control in heating mode, the control reference water temperature position setting
- If the air / leaving water temperature selection setting is set to leaving water temperature
- Change setting values using [,<,>(left/right)] button
- The function is not available for some products.

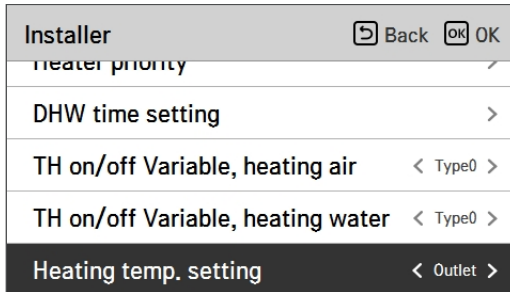

Value	
Outlet (Default)	Inlet

Pump setting in heating

- It is a function to help the water pump's mechanical life by putting the water pump's rest time
- Installer setting function to set water pump operation / delay time option in heating mode
- In the installer setting list, select Pump setting in heating category, and press [OK] button to move to the detail screen.

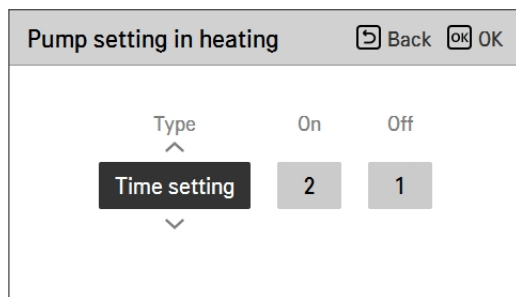
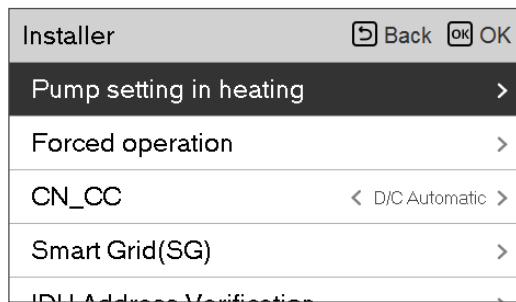

Type	Time setting	Operation continue
On	1 min ~ 60 min	-
Off	1 min ~ 60 min	-

Forced operation

- If the product is not used for a long time, the product will be forced to operate to prevent pump failure and PHEX freezing
- Water pump off After 20 consecutive hours, disable / enable the logic that drives the water pump by itself
- In the installer setting list, select Forced operation category, and press [OK] button to move to the detail screen

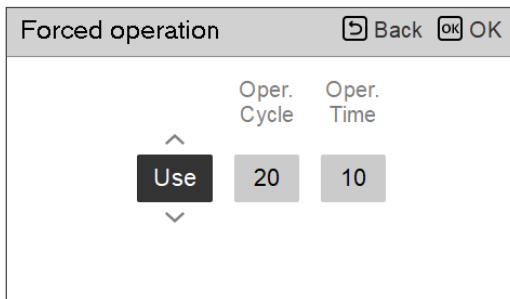
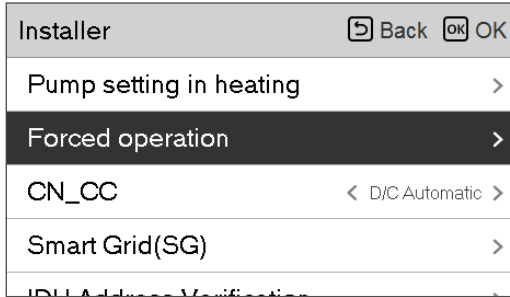

Type	Use	Not use
Oper. Cycle	20 hours ~ 180 hours	-
Oper. Time	1 min ~ 10 min	-

CN_CC

It is the function to set the usage of the unit's CN_CC port.

- Change setting values using [<,>(left/right)] button

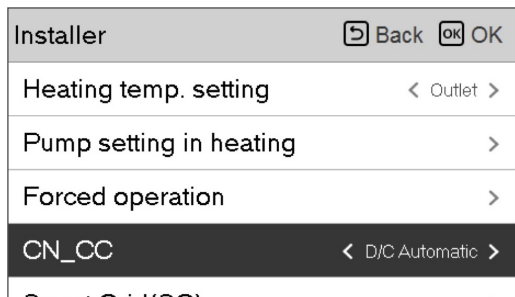

Value	Description
D/C Automatic	When power is applied to the product, the unit when the contact point is on in Dry Contact installed state recognizes Dry Contact installation
D/C Not Installed	Do not use (install) Dry Contact
D/C Installed	Use (install) Dry Contact

NOTE

CN_CC is the device connected to the unit to recognize and control the external contact point.

Smart Grid(SG)

It is the function to enable / disable the SG Ready function and to set the reference value at SG2 step.

- In the installer setting list, select Smart Grid(SG) category, and press [OK] button to move to the detail screen.

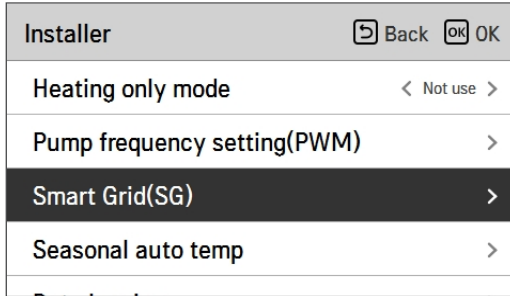

Value	Mode
Not use (Default)	-
Use	Step 0
	Step 1
	Step 2

IDU Address Verification

It is function to check the result of Auto Addressing of outdoor unit with remote control. IDU address setting function is available from indoor unit.

- In the installer setting list, select IDU Address Verification, and press [OK] button to move to the detail screen.

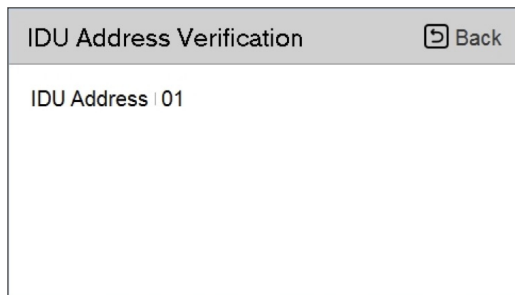
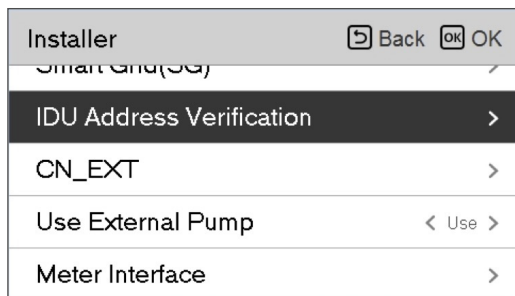

CN_EXT

It is a function to control external input and output according to DI type set by customer using CN-EXT Port.

- In the installer setting list, select CN-EXT Port category, and press [OK] button to move to the detail screen.

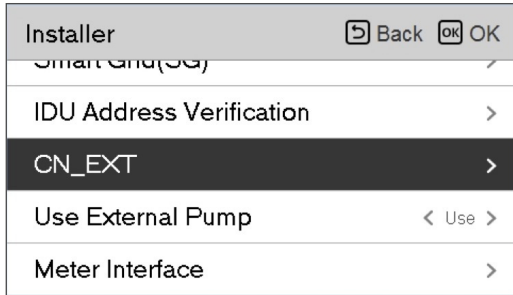

Value			
Not use	Simple Operation	Simple Dry Contact	Single emergency stop

Use External Pump

This function can be set to control the external water pump.

- In the installer setting list, select Use External Pump category, and press [OK] button to move to the detail screen.

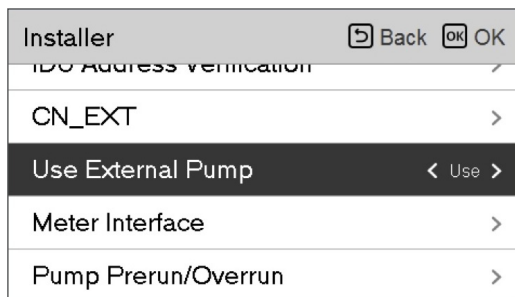

Value	
Not use	Use

Pump Prerun/Overrun

Pump Prerun operates to ensure sufficient flow before the compressor is operated. This is a function that allows heat exchange to work smoothly.

Pump Overrun is a function to prevent water pump failure and to help mechanical life. If the water pump has been off for 20 hours, Water pump will operate for the set time

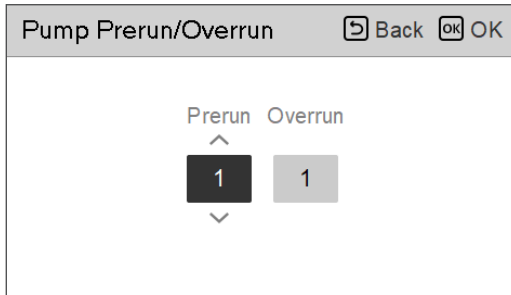
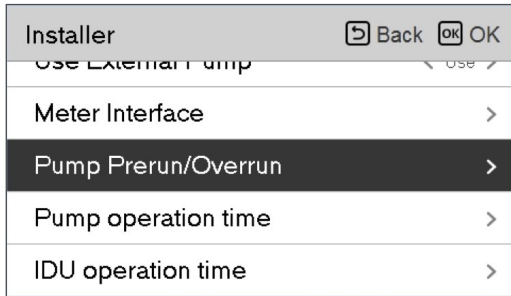

Value	Default	Setting Range
Prerun	1 min	1~10 min
Overrun	1 min	1~10 min

Data logging

It is the function to set the operation reference value in Seasonal Auto mode.

- In the installer setting list, select Data logging category, and press [OK] button to move to the detail screen.

Installer		Back	OK
Water Interface			>
Pump Prerun/Overrun			>
Pump operation time			>
IDU operation time			>
Data logging			>



Data logging					Back
Date	Time	Oper.	Settemp	In/Out	
1970.01.01	00:10	Off	-	24° / 25°	
1970.01.01	00:09	Off	-	24° / 25°	
1970.01.01	00:09	Off	-	24° / 25°	>
1970.01.01	00:09	Off	-	24° / 25°	
1970.01.01	00:09	Off	-	24° / 25°	

NOTE

Error history lookup range: 50

Error history information

Item: date, time, mode (including Off), set temperature, incoming temperature, outgoing temperature, room temperature, Hot water operation / stop, Hot water set temperature, Hot water temperature, Outdoor unit On / Off, Error code

Number of Display: Within 50

- Save criteria ▾

▾ Error occurred, released ON / OFF of outdoor unit operation.

Password Initialization

It is the function to initialize (0000) when you forgot the password set in the remote controller.

- In the installer setting list, select the password initialization setting category, and press [OK] button to move to the detail screen.
- When you press "initialization" button, a popup screen appears, and when you press "check" button, password initialization starts, and the user password is changed to 0000.

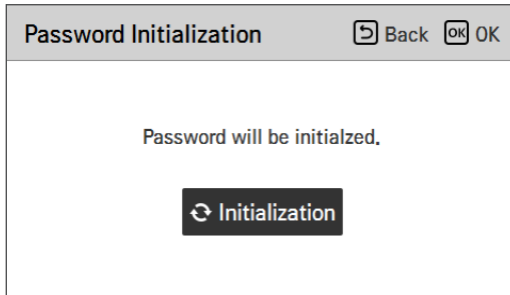
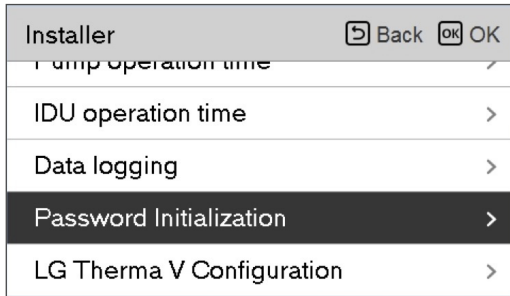

Power Supply Blockage (SG Ready)

The heat pump operated automatically by the power supply status signals from power supply companies. This function can respond to European countries' special tariff for heat pump using on a smart grid.

4 modes
depending on
power supply status

Power Supply Status



Operating Mode

0:0 [Normal Operation]

The heat pump works at maximum efficiency.

1:0 [Switch-off command, Utility lock]

Deactivates the heat pump to avoid peak load. The maximum blocking time depends on the system's thermal storage capacity, but amounts to at least 2 hours 3 times a day. (No frost protection)

0:1 [Switch-on recommendation]

The switch-on recommendation and set value storage tank temperature is increased, depending on the parameter "Mode SG"

Mode SG : set temperature + α
depending on the below
parameter

Step 0 (DHW +5 °C)

Step 1 (H/P+2 °C, DHW +5 °C)

Step 2 (H/P+5 °C, DHW +7 °C)

1:1 [Switch-on command]

The command activates the compressor. Optionally, electrical booster heaters can be activated to utilize electricity surpluses.

Overview settings

Menu Structure

Menu		
	→ Sub function	
	→ Service contact79
	→ Model information80
	→ RMC version Information81
	→ Open source license82
	→ Installer	
	→ 3 Minutes Delay86
	→ Select Temperature Sensor87
	→ Dry Contact Mode88
	→ Central Control Address89
	→ Pump Test run90
	→ Air heating set temp.91
	→ Water heating set temp92
	→ DHW set temp93
	→ Tank disinfection setting 1, 297
	→ Tank setting 198
	→ Tank setting 299
	→ DHW time setting100
	→ TH on/off Variable, heating air101
	→ TH on/off Variable, heating water102
	→ Heating temp. setting103
	→ Pump setting in heating104
	→ Forced operation105
	→ CN_CC106
	→ Smart Grid(SG)107
	→ IDU Address Verification108

→	CN_EXT	109
→	Use External Pump	110
→	Pump Prerun/Overrun	111
→	Data logging	112
→	Password Initialization	113

COMMISSIONING

If everything is going well until now, it is time to start the operation and to take advantages of **THERMAV**.

Before starting operation, pre-check points are described in this chapter. Some comments about maintenance and how to do troubleshooting are presented.

Check List before Starting Operation

CAUTION

Turn off the power before changing wiring or handling product.

No	Category	Item	Check Point
1	Electricity	Field wiring	<ul style="list-style-type: none"> All switches having contacts for different poles should be wired tightly according to regional or national legislation. Only qualified person can proceed wiring. Wiring and local-supplied electric parts should be complied with European and regional regulations. Wiring should be following the wiring diagram supplied with the product.
2		Protective devices	<ul style="list-style-type: none"> Install ELB (earth leakage breaker) with 25 mA. ELB inside the control box of the unit should be turned on before starting operation.
3		Earth wiring	<ul style="list-style-type: none"> Earth should be connected. Do not earth to gas or city water pipe, metallic section of a building, surge absorber, etc.
4		Power supply	<ul style="list-style-type: none"> Use dedicated power line.
5		Terminal block wiring	<ul style="list-style-type: none"> Connections on the terminal block (inside the control box of the unit) should be tightened.
6	Water	Charged water pressure	<ul style="list-style-type: none"> After water charging, the pressure gage (in front of the unit) should indicate 2.0~2.5 bar. Do not exceed 3.0 bar.
7		Air purge	<ul style="list-style-type: none"> During water charging, air should be taken out through the hole of the air purge. If water does not splash out when the tip (at the top of the hole) is pressed, then air purging is not completed yet. If well purged, the water will splash out like fountain. Be careful when testing air purge. Splashed water may make your dress wet.
8		Shut-off valve	<ul style="list-style-type: none"> Two shut-off valves (located at the end of water inlet pipe and water outlet pipe of the unit) should be open.
9		By-pass valve	<ul style="list-style-type: none"> By-pass valve should be installed and adjusted to secure enough water flow rate. If water flow rate is low, flow switch error (CH14) can be occurred.
10	Product Installation	Parts inspection	<ul style="list-style-type: none"> There should be no apparently damaged parts inside the unit.
11		Refrigerant leakage	<ul style="list-style-type: none"> Refrigerant leakage degrades the performance. If leakage found, contact qualified LG air conditioning installation person.
12		Drainage treatment	<ul style="list-style-type: none"> While cooling operation, condensed dew can drop down to the bottom of the unit. In this case, prepare drainage treatment (for example, vessel to contain condensed dew) to avoid water drop.

To assure best performance of **THERMAV**, it is required to perform periodical check and maintenance. It is recommended to proceed following check list for once a year.



CAUTION

Turn off the power before proceeding maintenance.

No	Category	Item	Check Point
1	Water	Water pressure	<ul style="list-style-type: none"> • In normal state, the pressure gauge (in front of the unit) should indicate 2.0~2.5 bar. • If the pressure is less than 0.3 bar, please recharge the water.
2		Strainer(Water filter)	<ul style="list-style-type: none"> • Close the shut-off valves and disassemble strainer. Then wash the strainer to make it clean. • While disassembling the strainer, be careful for water flood out.
3		Safety valve	<ul style="list-style-type: none"> • Open the switch of the safety valve and check if water is flood out through the drain hose. • After checking, close the safety valve.
4	Electricity	Terminal block wiring	<ul style="list-style-type: none"> • Look and inspect if there is loosen or defected connection on the terminal block.

Starting Operation

Check before Starting Operation

1	Check to see whether there is any refrigerant leakage, and check whether the power or transmission cable is connected properly.
2	<p>Confirm that 500 V megger shows 2.0 MΩ or more between power supply terminal block and ground. Do not operate in the case of 2.0 MΩ or less.</p> <p>NOTE: Never carry out mega ohm check over terminal control board. Otherwise the control board may break.</p> <p>Immediately after mounting the unit or after leaving it turned off for an extended length of time, the resistance of the insulation between the power supply terminal board and the ground may decrease to approx. 2.0 MΩ as a result of refrigerant accumulation in the internal compressor.</p> <p>If the insulation resistance is less than 2.0 MΩ, turn on the main power supply.</p>
3	When the power is applied for the first time, operate the product after preheating for 2 hours. To protect the unit by increasing the oil temperature of the compressor.

Starting Operation flow chart

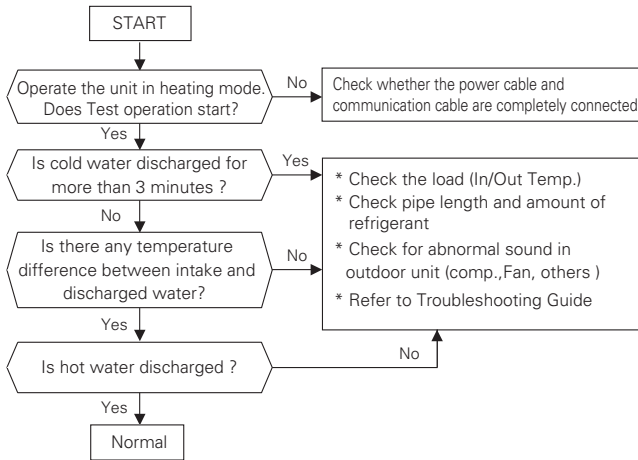

Airborne Noise Emission

The A-weighted sound pressure emitted by this product is below 70 dB.

** The noise level can vary depending on the site.

The figures quoted are emission level and are not necessarily safe working levels.

Whilst there is a correlation between the emission and exposure levels, this cannot be used reliably to determine whether or not further precautions are required.

Factor that influence the actual level of exposure of the workforce include the characteristics of the work room and the other sources of noise, i.e. the number of equipment and other adjacent processes and the length of time for which an operator exposed to the noise.

Also, the permissible exposure level can vary from country to country.

This information, however, will enable the user of the equipment to make a better evaluation of the hazard and risk.

Limiting concentration(R410A)

Limiting concentration is the limit of Freon gas concentration where immediate measures can be taken without hurting human body when refrigerant leaks in the air. The limiting concentration shall be described in the unit of kg/m^3 (Freon gas weight per unit air volume) for facilitating calculation

Limiting concentration : 0.44 kg/m^3 (R410A)

■ Calculate refrigerant concentration

$$\text{Refrigerant concentration} = \frac{\text{Total amount of replenished refrigerant in refrigerant facility (kg)}}{\text{Capacity of smallest room where indoor unit is installed (m}^3\text{)}}$$

Troubleshooting

If **THERMAV** operates not properly or it does not start operation, please check following list.



CAUTION

Turn off the power before proceeding troubleshooting.

Troubleshooting for Problem while Operation

No	Problem	Reason	Solution
1	Heating is not satisfactory.	<ul style="list-style-type: none"> Setting target temperature is not proper. 	<ul style="list-style-type: none"> Set target temperature correctly. Check if temperature is water-based or air-based. See 'Remote sensor active' and 'Temp. sensor selection' in Chapter6.
		<ul style="list-style-type: none"> Charged water is not enough. 	<ul style="list-style-type: none"> Check pressure gage and charge more water until pressure gage is indication 2~2.5 Bar
		<ul style="list-style-type: none"> Water flow rate is low. 	<ul style="list-style-type: none"> Check if strainer gathers too much particles. If so, strainer should be cleaned. Check if pressure gauge indicates above 4 Bar Check if water pipe is getting closed due to stacked particles or lime.
2	Although electric power supply is OK (remote controller displays information), the unit does not start working.	<ul style="list-style-type: none"> Water inlet temperature is too high. 	<ul style="list-style-type: none"> If water inlet temperature is above 78 °C, the unit does not operated for the sake of system protection
		<ul style="list-style-type: none"> Water inlet temperature is too low. 	<ul style="list-style-type: none"> If water inlet temperature is below 5 °C, the unit does not operated for the sake of system protection. Wait while unit warms up the water inlet temperature. If water inlet temperature is below 15 °C in heating operation, the unit does not operated for the sake of system protection. Wait while unit warms up to 18 °C the water inlet temperature.
3	Water is flood out through drain hose.	<ul style="list-style-type: none"> Too much water is charged. 	<ul style="list-style-type: none"> Flood out water by opening the switch of the safety valve until pressure gage is indicating 2~2.5 Bar.
4	DHW is not hot.	<ul style="list-style-type: none"> Thermal protector of water tank heater is activated. 	<ul style="list-style-type: none"> Open the side panel of the DHW tank and push the reset button of the thermal protector. (for more detail information, please refer to installation manual of DHW tank.)
		<ul style="list-style-type: none"> DHW Heating is disabled. 	<ul style="list-style-type: none"> Select DHW Heating Operation and identify if icon is displayed on the remote controller.

Troubleshooting for Error Code

Indoor Unit

- This function displays the disorder types at the self diagnostics and the occurrence of the disorder for the product.
 - The disorder display shows the code in the following table on the red/green LED of the wired remote controller and outdoor unit control board.
 - If two or more types of disorders occur simultaneously, it displays in the order of the error number.
 - After error occurs, the error code disappears when the disorder is repaired.
- * Error code 01, 08, 17, 18 can be operated with emergency operation.

Error No.	Error Type	Main Reasons
CH01	Air temperature sensor error	Air temperature sensor disconnection or short circuit
CH03	No communication between wired remote controller & indoor unit	The remote controller does not receive the signal from indoor unit during specific time
CH05	Indoor unit & outdoor unit communication error	No signal communication between indoor unit & outdoor unit
CH08	Water tank temperature sensor error	Water tank temperature sensor disconnection or short circuit
CH09	Indoor unit EEPROM error	Communication between the micro-processor & the EEPROM / Error due to EEPROM damage
CH11	Indoor unit & inverter PCB communication error	No signal communication between indoor unit & inverter PCB
CH12	Inverter PCB error	Error occurrence in inverter PCB
CH13	Problem in Solar-thermal sensor	Solar pipe temperature sensor of indoor unit is open or short.
CH14	Flow switch error	Abnormal working of flow switch
CH15	Water pipe overheated	Water outlet temperature is above 90 °C
CH16	Water inlet & outlet temperature sensor error	Water inlet & outlet temperature sensor disconnection or short circuit simultaneously
CH17	Water inlet temperature sensor error	Water inlet temperature sensor disconnection or short circuit
CH18	Water outlet temperature sensor error	Water outlet temperature sensor disconnection or short circuit

Inverter PCB error display method

Red LED means error number 10 digits, and green LED means 1 digit, and if red and green blink at the same time, it means the unit of 100.

Ex) Inverter compressor IPM defect Error : error number 21

Error Code	Description	LED 1 (Red)	LED 2 (Green)
21	Inverter compressor IPM defect	2times ●	1time ●

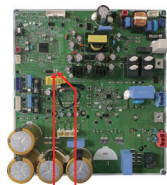

Red LED1: 10 digits
Green LED2: 1 digit

Error No.	Error Type	Main Reasons
bc21	Inverter compressor IPM defect	Inverter compressor drive IPM defect / inverter compressor defect
bc22	Inverter compressor overcurrent	Increase of inverter compressor CT value
bc23	Inverter compressor DC Link low voltage	After inverter activation relay is ON, DC voltage recharge defect
bc25	High/low Inverter input voltage	Inverter input voltage exceeds the unit limit and lasts for 4 s (173V ~ 289V)
bc26	Inverter compressor activation failure	Inverter compressor error, causing initial activation failure
bc27	Inverter PSC/PFC Fault Error	Error by overcurrent at inverter input
bc28	Inverter DC Link high voltage error	Inverter DC voltage recharge, causing compressor OFF
bc29	Inverter compressor overcurrent	Inverter compressor activation failure or increase of CT value
bc32	Excessive rise of inverter compressor discharge temperature	Excessive rise of inverter compressor discharge temperature, causing compressor OFF
bc34	Excessive rise of high pressure of inverter compressor	Excessive rise of high pressure of inverter compressor, causing compressor OFF
bc35	Excessive drop of low pressure of inverter compressor	Excessive drop of low pressure of inverter compressor, causing compressor OFF
bc36	Low pressure ratio error of inverter compressor	High pressure/low pressure ratio of inverter compressor is maintained at below 1.8 for 3 min. or more
bc40	Inverter compressor CT sensor defect	Inverter compressor CT sensor defect
bc41	Inverter compressor discharge pipe temperature sensor defect	Inverter compressor discharge temperature sensor disconnection or short circuit
bc42	Low pressure sensor defect of inverter compressor	Low pressure sensor disconnection or short circuit of inverter compressor
bc43	High pressure sensor defect of inverter compressor	High pressure sensor disconnection or short circuit of inverter compressor
bc44	Inverter inside air temperature sensor defect	Inverter inside air temperature sensor disconnection or short circuit
bc46	Inverter compressor suction pipe temperature sensor defect	Inverter compressor suction temperature sensor disconnection or short circuit
bc53	Communication error(indoor unit → outdoor unit main PCB)	Outdoor unit does not receive signal from indoor unit
bc60	Inverter PCB EEPROM error	Inverter PCB EEPROM error
bc62	Excessive rise of inverter heatsink temperature	Inverter PCB heat generation, causing the rise of heatsink temperature
bc65	Inverter heatsink temperature sensor defect	Inverter heatsink temperature sensor disconnection or short circuit
bc73	Overcurrent (Peak) detected at inverter input	Error by overcurrent detection at inverter input

Outdoor Unit

• Error Indicator

- This function indicates types of failure in self-diagnosis and occurrence of failure for air condition.
- Error mark is displayed on display window of indoor units and wired remote controller, and 7-segment LED of outdoor unit control board as shown in the table.
- If more than two troubles occur simultaneously, lower number of error code is first displayed.
- After error occurrence, if error is released, error LED is also released simultaneously.

• Error Display

1st,2nd LED of 7-segment indicates error number, 3rd LED indicates unit number.

			Error No.	Error Type	Main Reasons
Outdoor unit related error (CH)	2	1	1	Inverter compressor IPM defect	Inverter compressor drive IPM defect / inverter compressor defect
	2	2	1	Inverter compressor over current	Increase of inverter compressor CT value
	2	3	1	Inverter compressor DC Link low voltage	After inverter activation relay is ON, DC voltage recharge defect
	2	4	1	Outdoor Unit High Pressure Switch	System is turned off by outdoor unit high pressure switch.
	2	5	1	High/low Inverter input voltage	Inverter input voltage exceeds the unit limit and lasts for 4 s (173V ~ 289V)
	2	6	1	Inverter compressor activation failure	Inverter compressor error, causing initial activation failure
	2	7	1	Inverter PSC/PFC Fault Error	Error by overcurrent at inverter input
	2	8	1	Inverter DC Link high voltage error	Inverter DC voltage recharge, causing compressor OFF
	2	9	1	Inverter compressor overcurrent	Inverter compressor activation failure or increase of CT value
	3	2	1	Excessive rise of inverter compressor discharge temperature	Excessive rise of inverter compressor discharge temperature, causing compressor OFF
	3	4	1	Excessive rise of high pressure of inverter compressor	Excessive rise of high pressure of inverter compressor, causing compressor OFF
	3	5	1	Excessive drop of low pressure of inverter compressor	Excessive drop of low pressure of inverter compressor, causing compressor OFF
	3	6	1	Low pressure ratio error of inverter compressor	High pressure/low pressure ratio of inverter compressor is maintained at below 1.8 for 3 min. or more
	4	0	1	Inverter compressor CT sensor defect	Inverter compressor CT sensor defect
	4	1	1	Inverter compressor discharge pipe temperature sensor defect	Inverter compressor discharge temperature sensor disconnection or short circuit
	4	2	1	Low pressure sensor defect of inverter compressor	Low pressure sensor disconnection or short circuit of inverter compressor
	4	3	1	High pressure sensor defect of inverter compressor	High pressure sensor disconnection or short circuit of inverter compressor
	4	4	1	Inverter inside air temperature sensor defect	Inverter inside air temperature sensor disconnection or short circuit
4	5	1	Outdoor Unit Heat Exchanger Temperature Sensor Fault	Outdoor Unit Heat Exchanger Temperature Sensor Open or Short	

				Error No.	Error Type	Main Reasons
Outdoor unit related error (CH)	4	6	1	Inverter compressor suction pipe temperature sensor defect	Inverter compressor suction temperature sensor disconnection or short circuit	
	4	9	1	Defective IPM Temperature Sensor	Disconnection or short circuit on IPM temperature sensor of the outdoor unit	
	5	2	1	Communication error : inverter PCB → Main PCB	Failing to receive inverter signal at main PCB of Outdoor Unit	
	5	3	1	Communication error(indoor unit → outdoor unit main PCB)	Outdoor unit does not receive signal from indoor unit	
	5	7	1	Communication error : inverter PCB → Main PCB	Restriction of Outdoor Unit (Inverter PCB)	
	6	0	1	Inverter PCB EEPROM error	Inverter PCB EEPROM error	
	6	2	1	Excessive rise of inverter heatsink temperature	Inverter PCB heat generation, causing the rise of heatsink temperature	
	6	7	1	Outdoor Unit Fan Lock	Restriction of Outdoor Unit Fan	
	7	3	1	Overcurrent (Peak) detected at inverter input	Error by overcurrent detection at inverter input	
	8	6	1	Outdoor Unit Main PCB EEPROM Error	Communication Fail Between Outdoor Unit Main MICOM and EEPROM or omitting EEPROM	
	8	8	1	PFC PCB EEPROM Error	Communication Fail Between Outdoor Unit PFC MICOM and EEPROM or omitting EEPROM	
	1	1	3	1	Outdoor Unit Liquid pipe Temperature Sensor Error	Liquid pipe temperature sensor of outdoor unit is open or short
	1	1	5	1	Outdoor Unit Subcooling Outlet Temperature Sensor Error	Outdoor Unit Subcooling Outlet Temperature Sensor open or short
	1	5	1	1	Failure of operation mode conversion at Outdoor Unit	Pressure unbalance between outdoor units



Eco design requirement

- The information for Eco design is available on the following free access website.
<https://www.lg.com/global/support/cedoc/cedoc>

[Representative] LG Electronics Inc. EU Representative : LG Electronics European Shared Service Center B.V. Krijgsman 1, 1186 DM Amstelveen, The Netherlands

[Manufacturer] LG Electronics Inc. Changwon 2nd factory 84, Wanam-ro, Seongsan-gu, Changwon-si, Gyeongsangnam-do, KOREA